

LEGO
MEGA

POKÉMON



HKT25
DRAGONITE
DRACOLOSSE

DRAGORAN



Build Construisez

Construye | Constrói
Bauen | Стройте



Share Partagez

Comparte | Partilha
Teilen | Делитесь



Easy-to-follow steps!

Des instructions faciles à suivre !

¡Pasos fáciles de seguir!
Passos fáceis de seguir!
Einfache Schritte!
Простые действия!



Devices not included | Appareils non inclus
Dispositivos no incluído | Dispositivos não incluídos
Geräte nicht enthalten | Устройства не входят в комплект



megaunboxed.com



BUILD WITH MOTION

CONSTRUIS UN MONDE EN MOVEMENT

Construye con movimiento
Construção com movimento
Bauen mit Aktion
Строй с движением



4



45



34



46



39



50





1

1x 1x 1x 1x

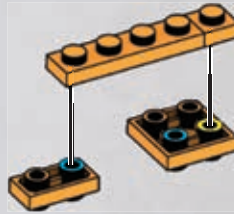

1



2

2

1x 1x 1x 1x

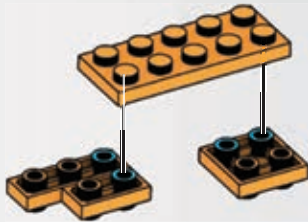

1



2

3

1x

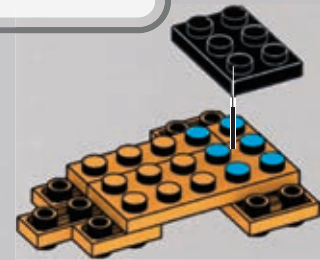

4

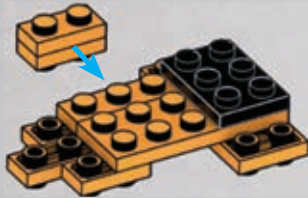

5

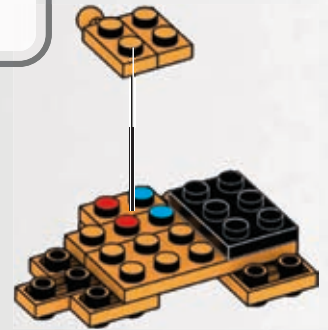
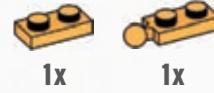

6

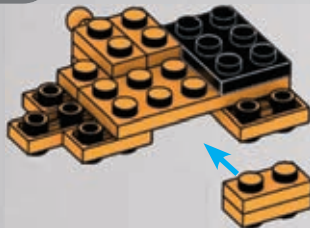

7

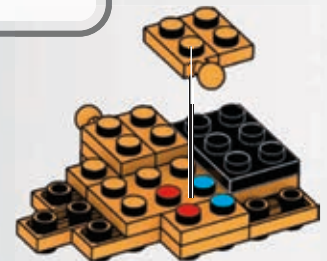
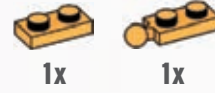

8



1x



1x

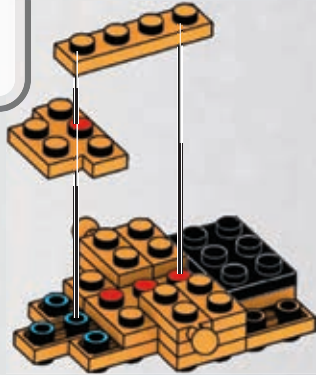

9



2x



1x

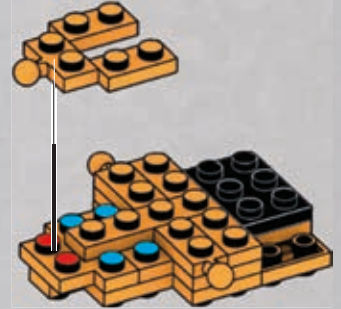

10



1x



1x



1x

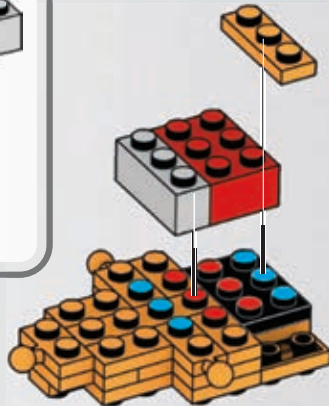

11



1x



2x



1x



1x

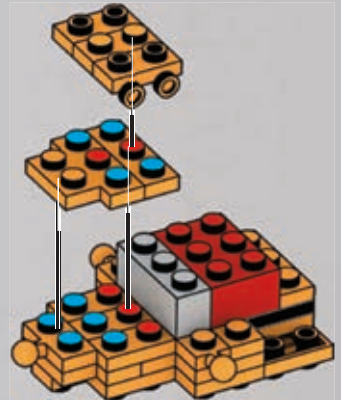

12



1x



2x

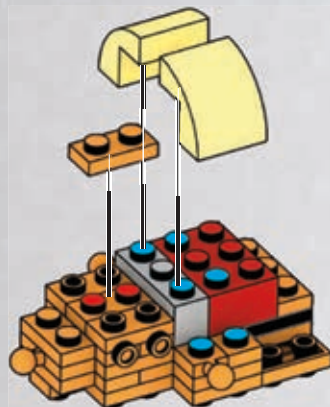

13



2x



2x

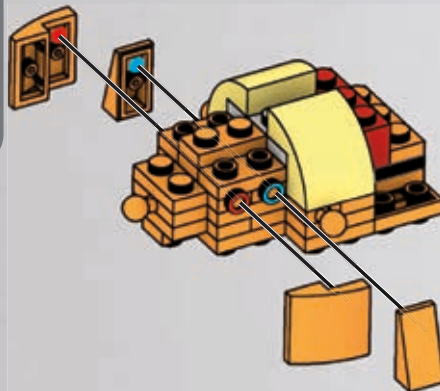

14



1x

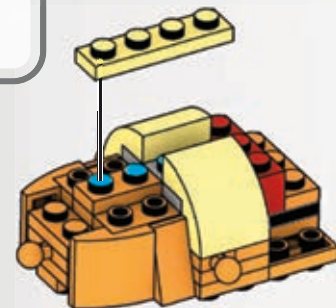

15



2x

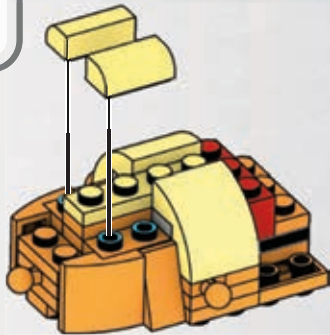

16



1x

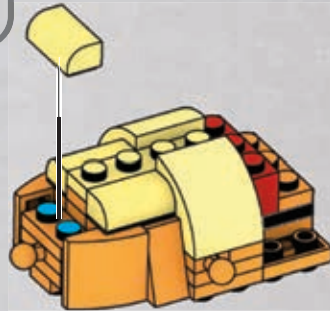

1



2

17



1x



1x

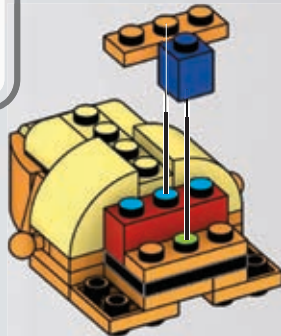

1

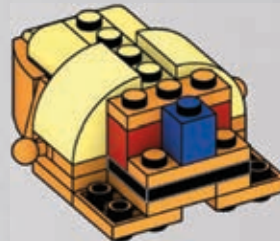

2

18



4x



2x



1x

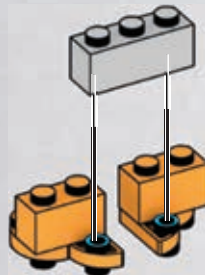

1

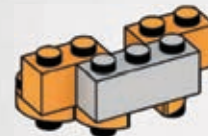
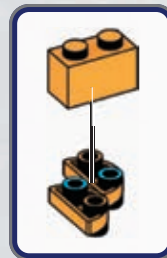

2

19



2x

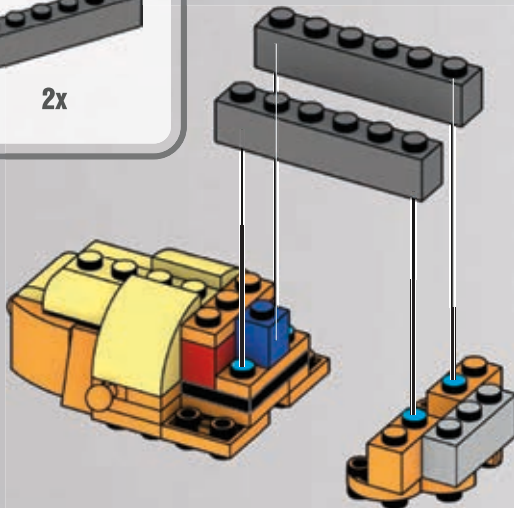

20



1x



1x

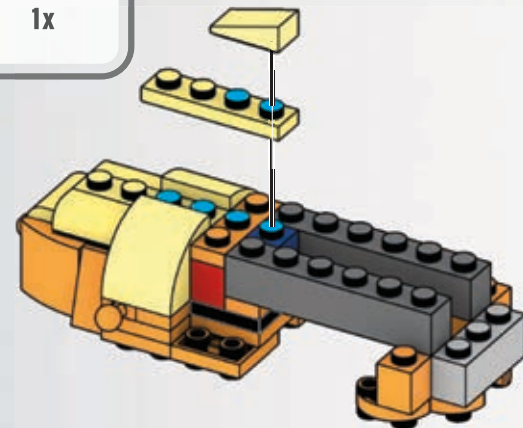

21

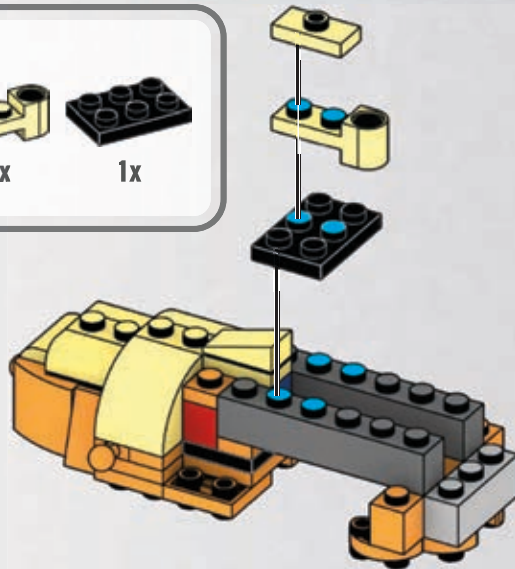

22

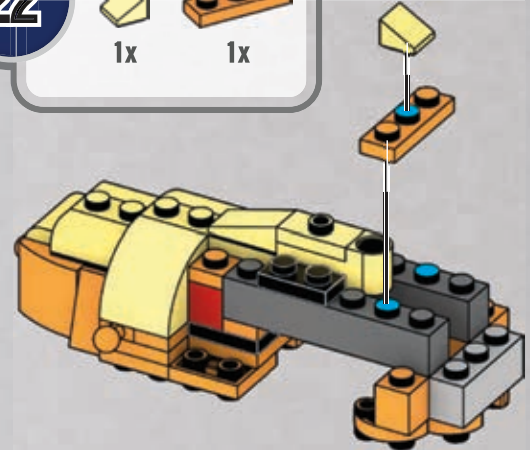

23

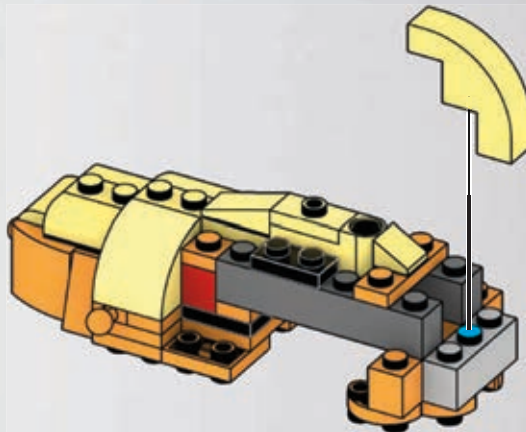

24

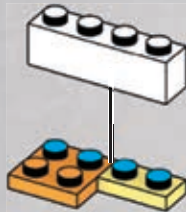

25

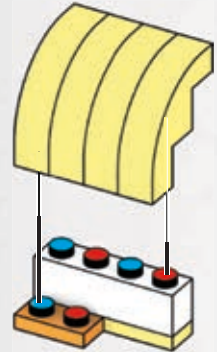

26

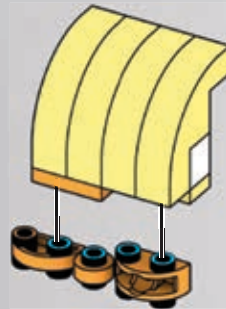
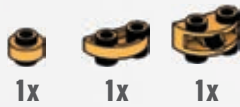

27

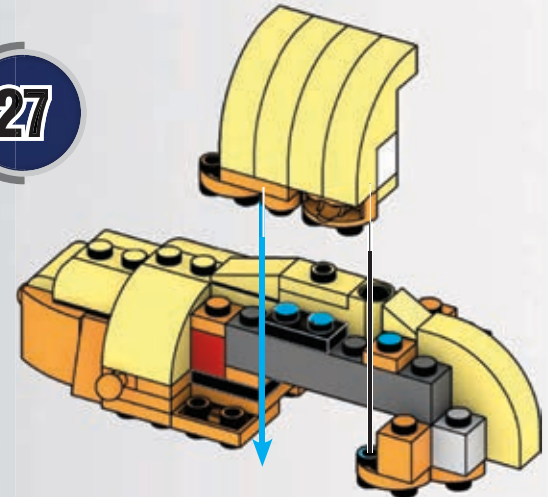

28



1x



1x

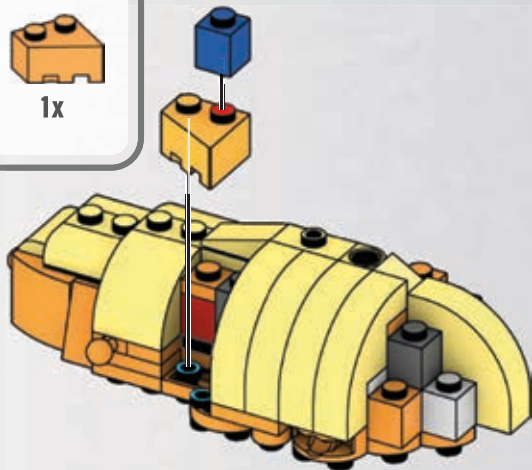

29



1x

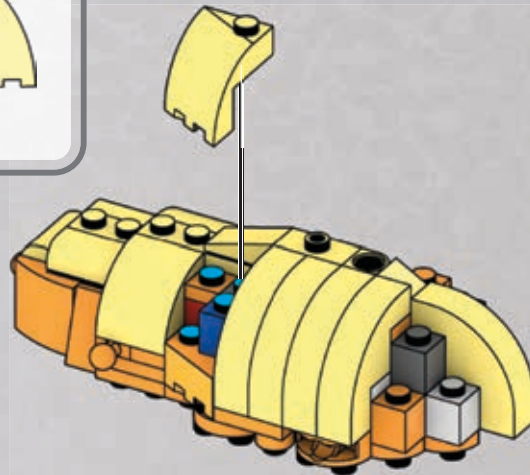

30



1x

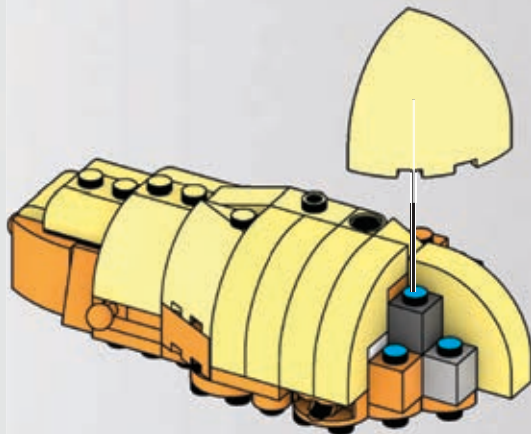

1

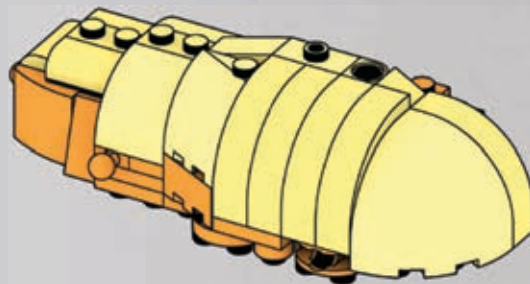

2

31

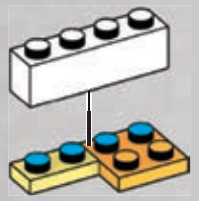

32

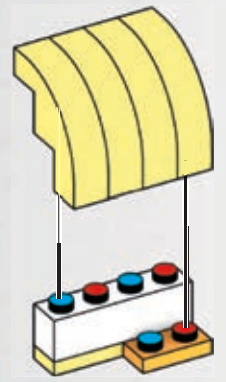

33

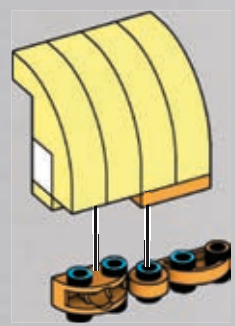
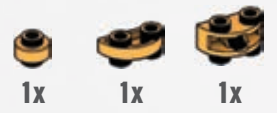

34

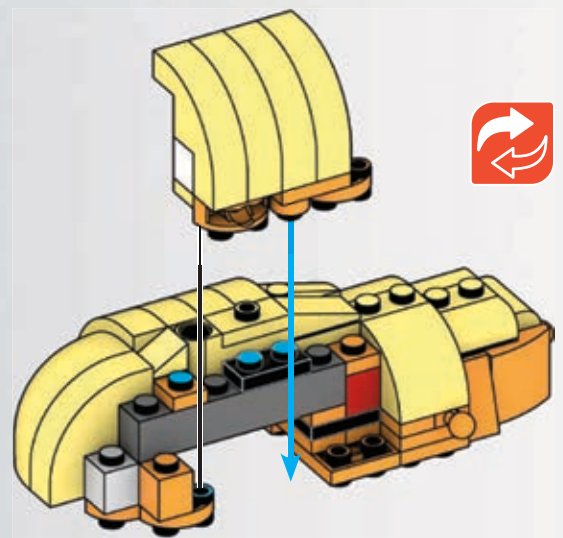

35



1x



1x

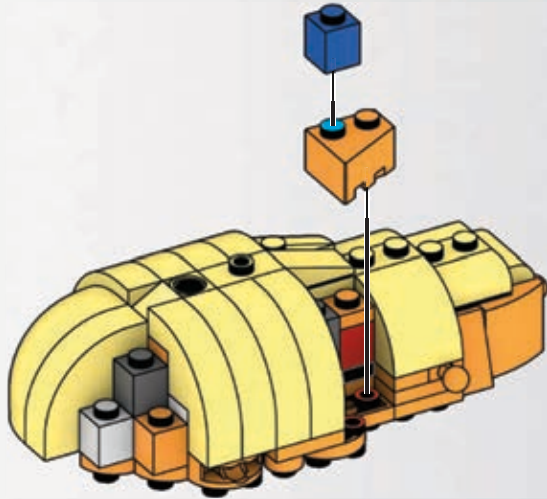

36



1x

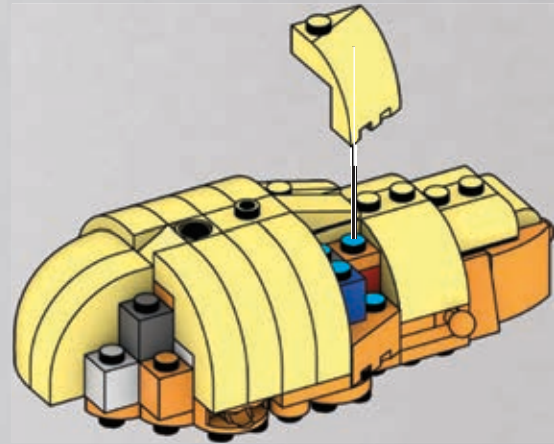

37



1x

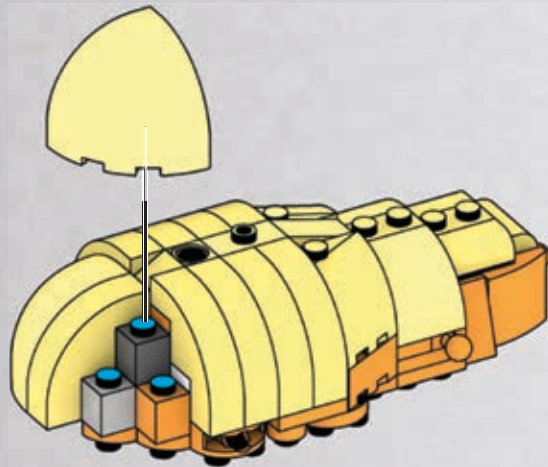

1

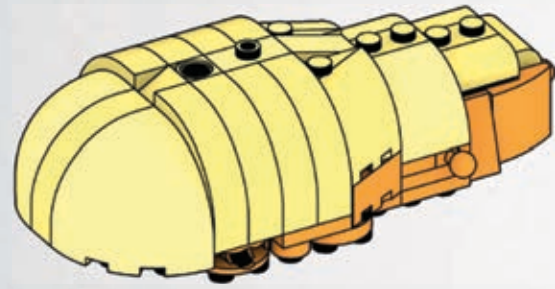

2

38



4x



2x

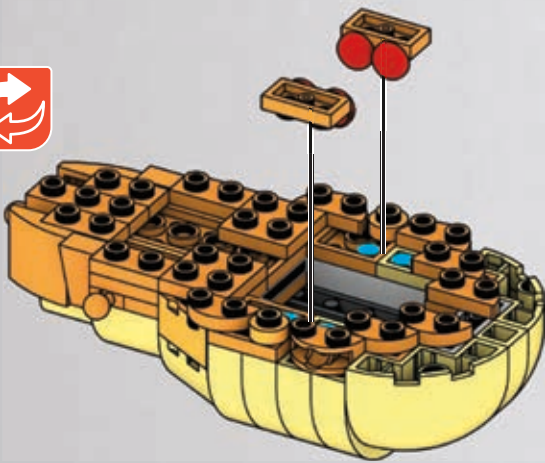

1

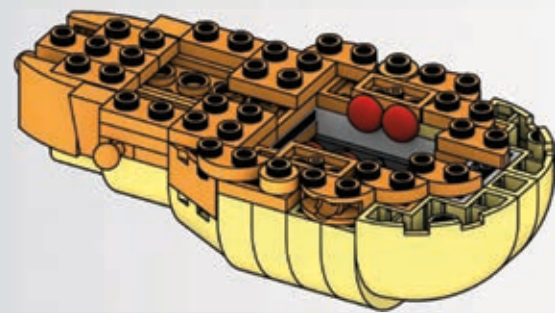

2

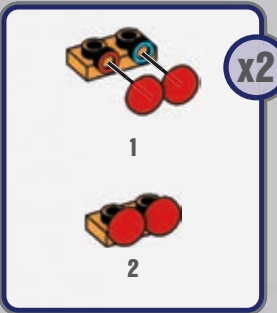

39



2x



1x



1x



40



2x



1



2

41



1x



1x



1x

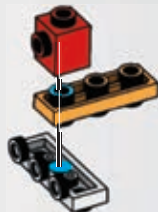

1

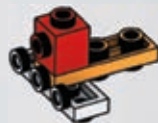

2

42

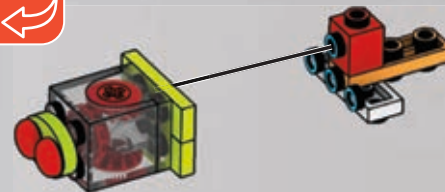

43



1x

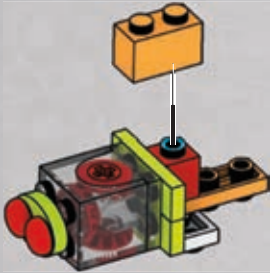

1

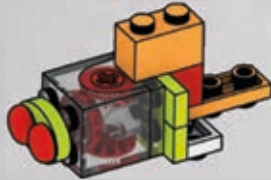

2

44

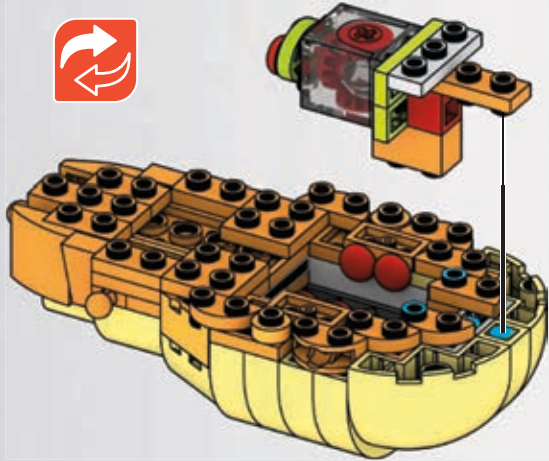

45



1x



1x



1x



1x

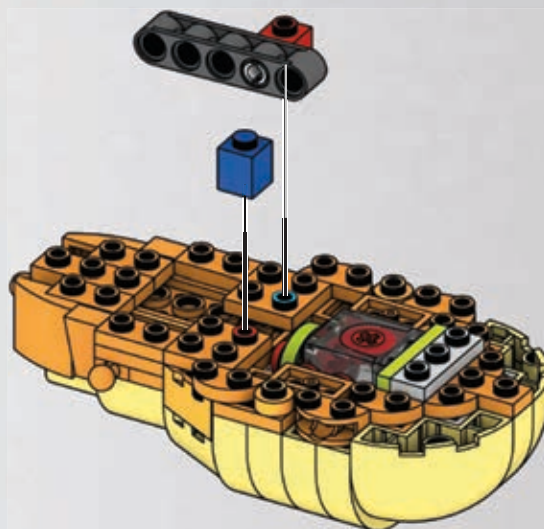
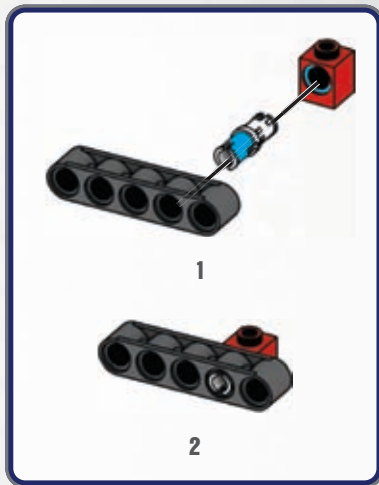

1

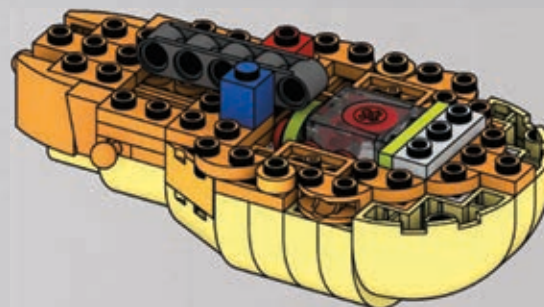

2

46



47

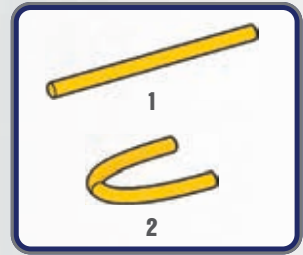

48

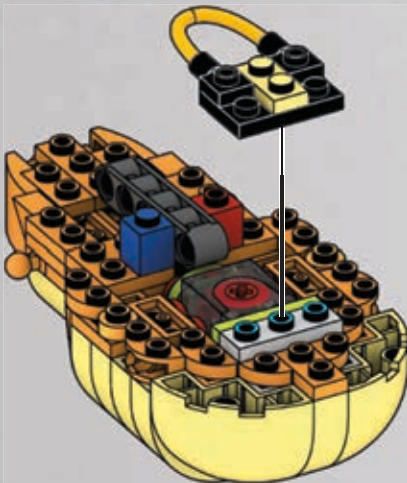

49

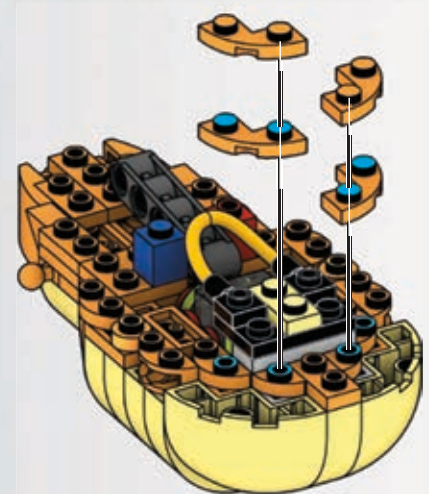

50



1x



1x

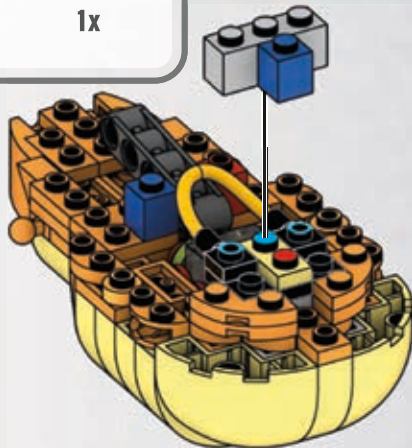

51



1x



1x



1x

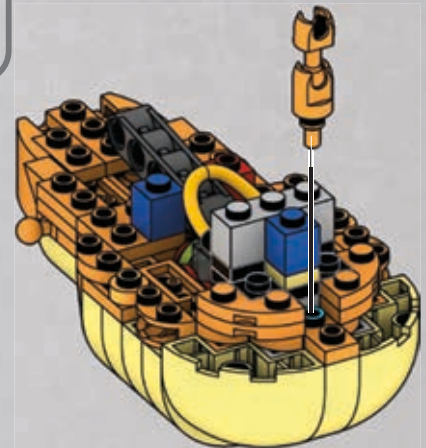
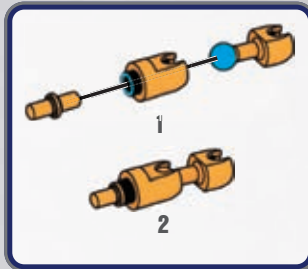

52



2x

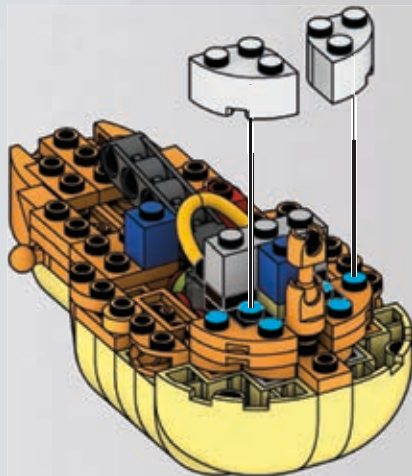

53

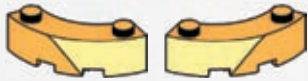

1x

1x



1x

1x

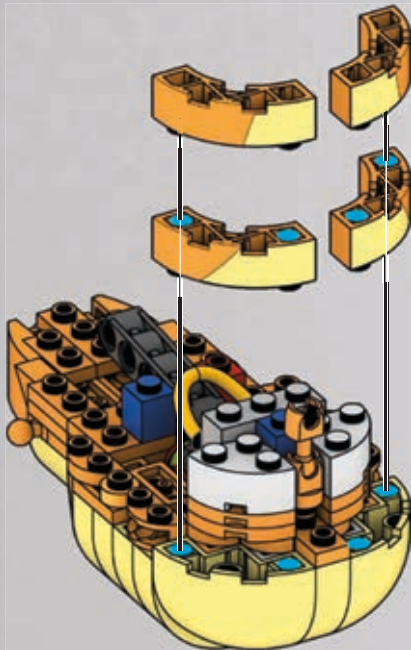

54



1x



1x



1x

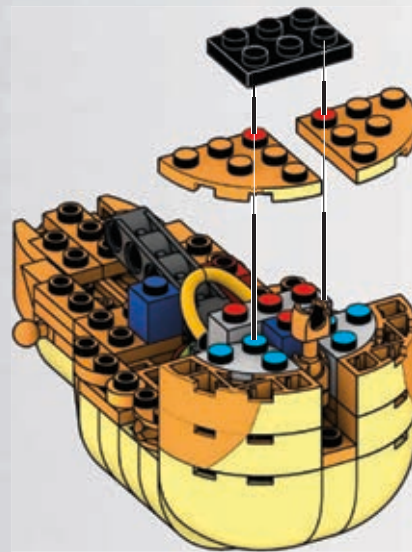

55



1x

1x

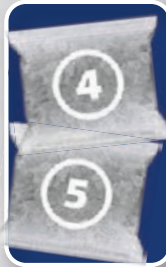
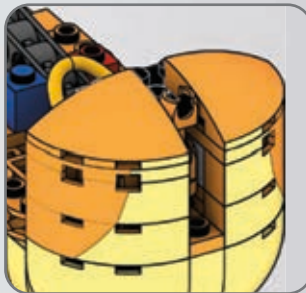
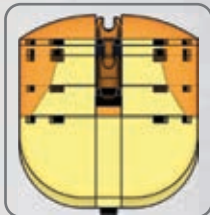
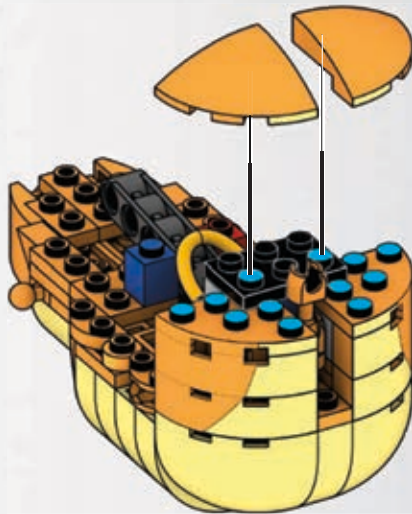

56



2x

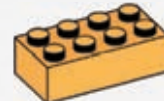

2x

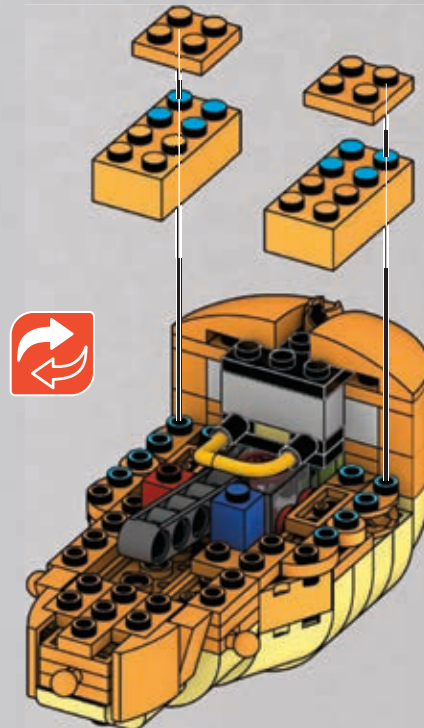

57



2x



2x

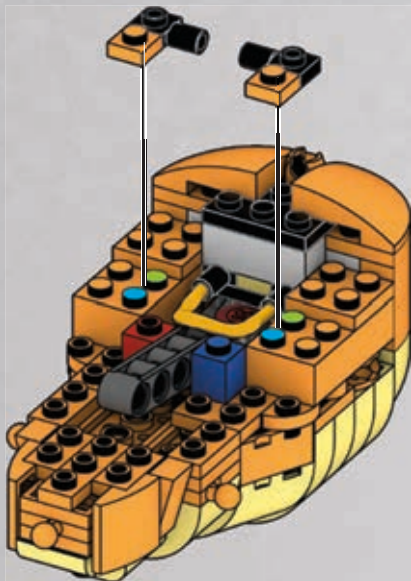

58



2x



2x



2x

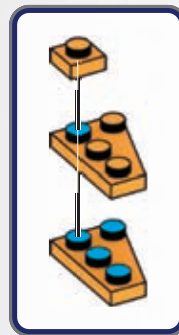
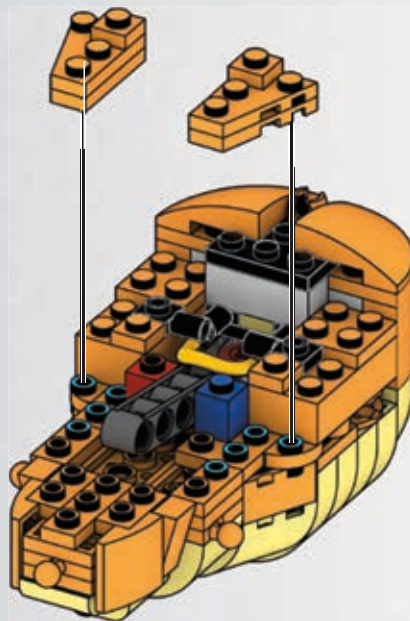
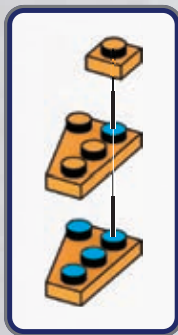

59



2x

1x

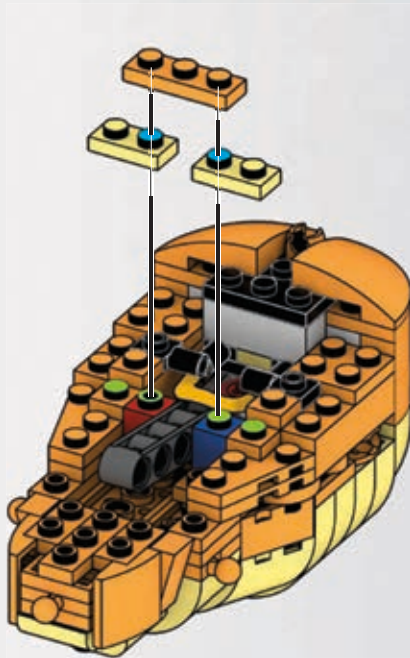

60



1x

1x

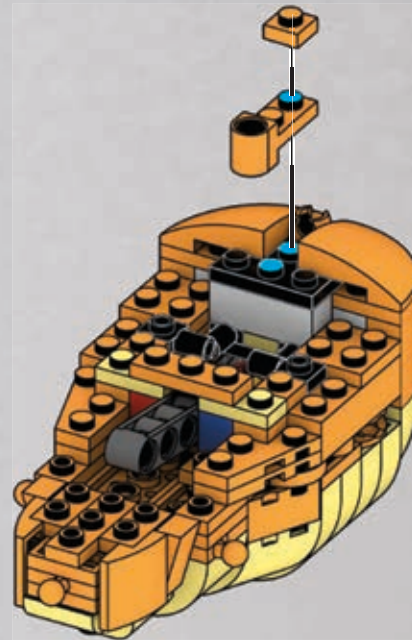

61



2x

2x

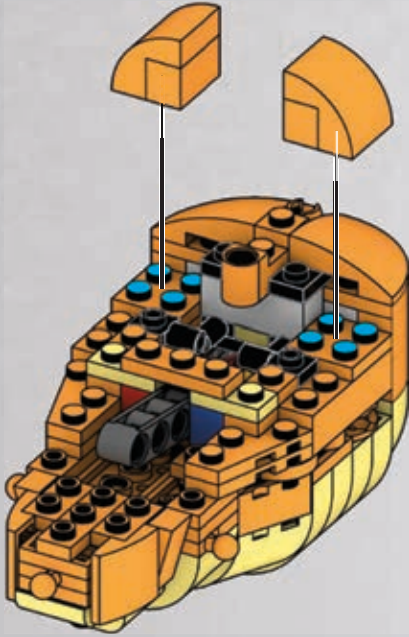
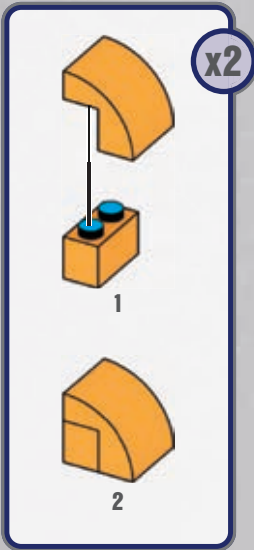

62



2x

1x

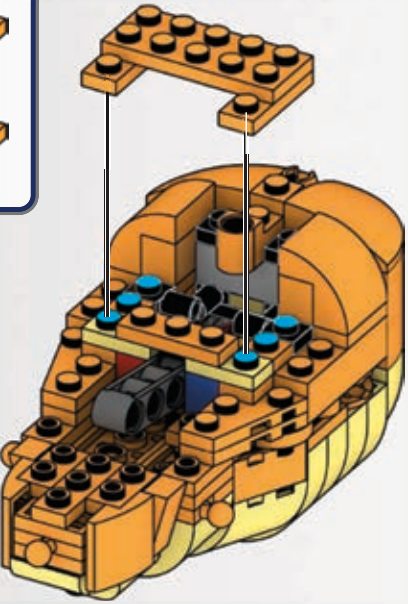
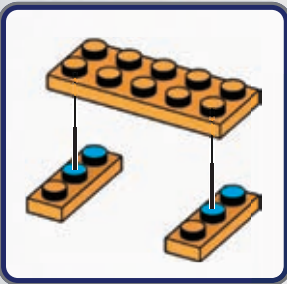

63



4x



1x

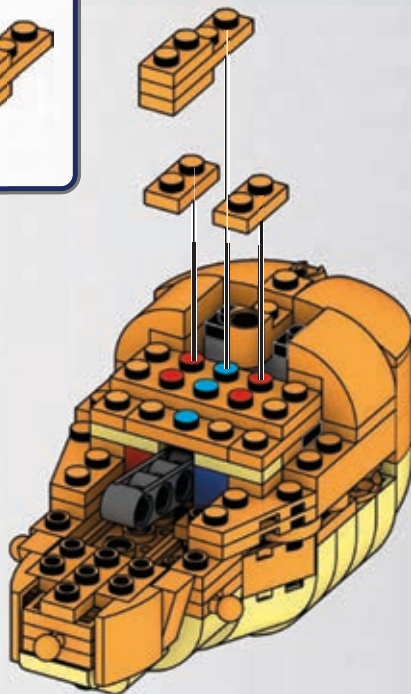
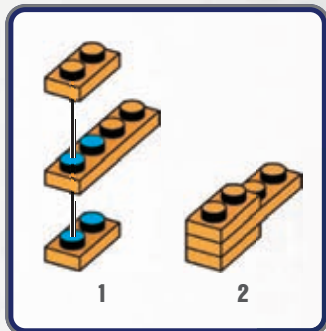

64



2x

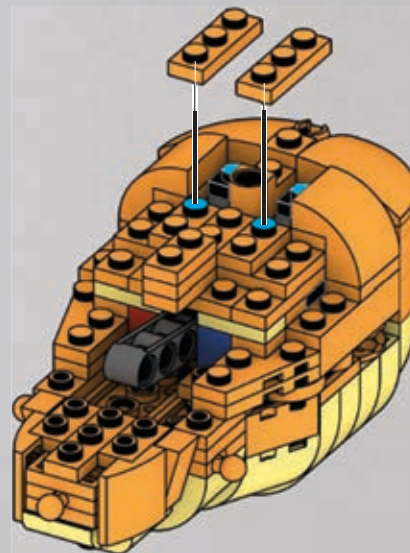

65



2x



1x

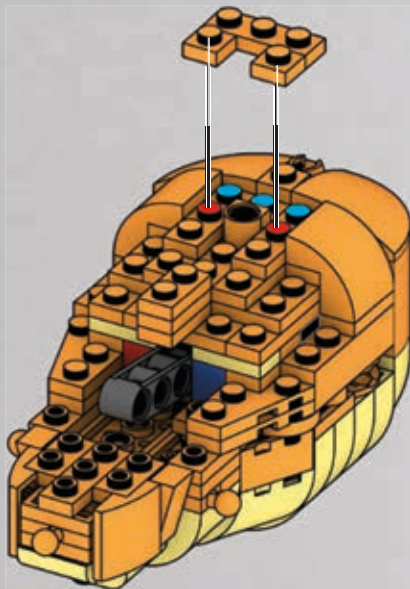

66



2x



1x



1x

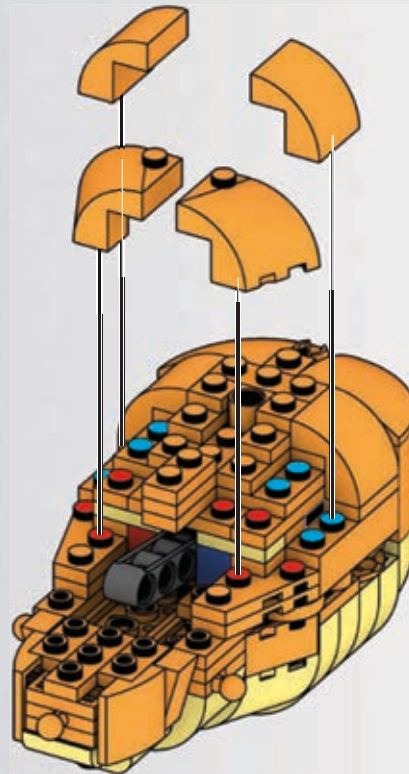

67



1x



1x

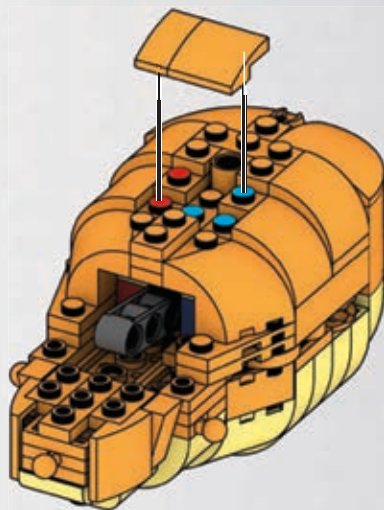

1

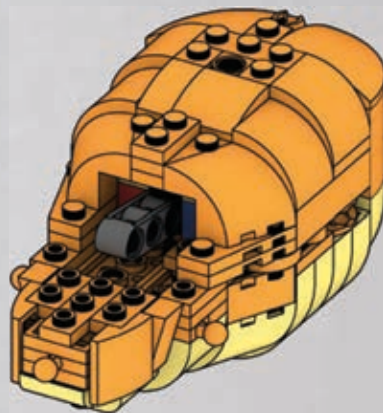

2

68



69



70



71

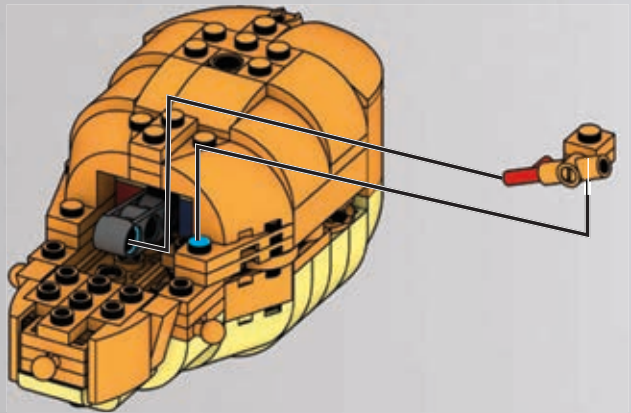

1

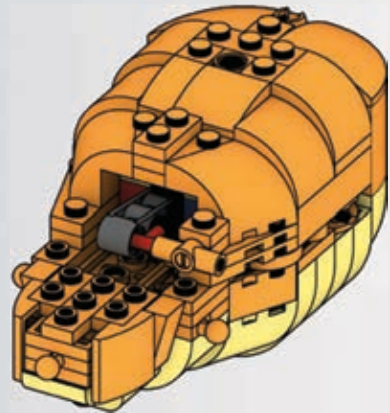

3

72



1x



1x

73



1x

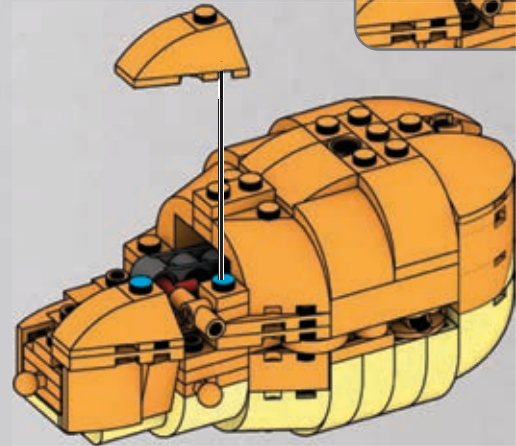
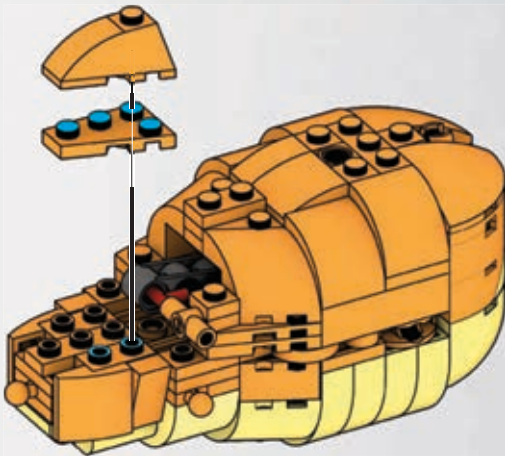

74



1x



1x

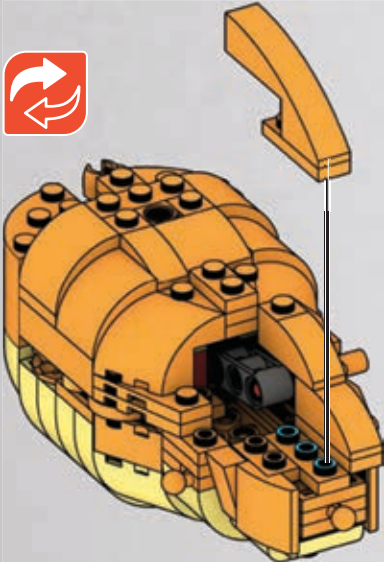
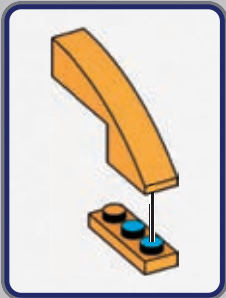

1

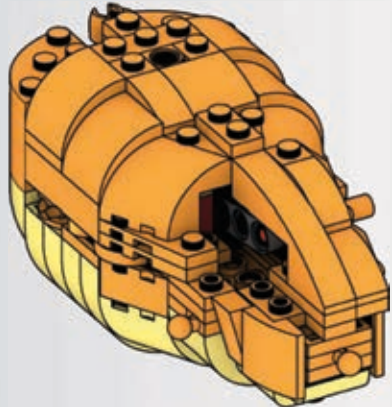

2

75



76

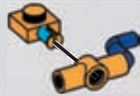

77



78

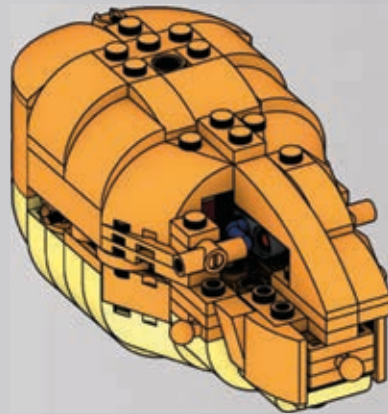
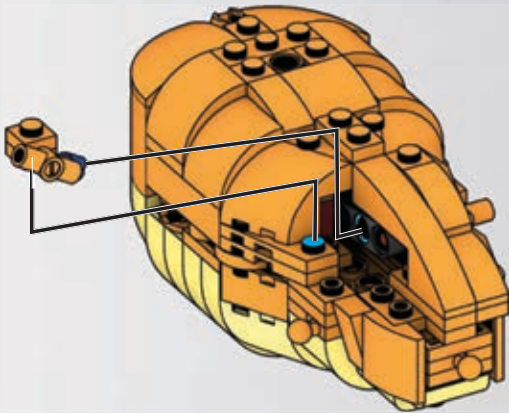

79



1x



1x

80



1x

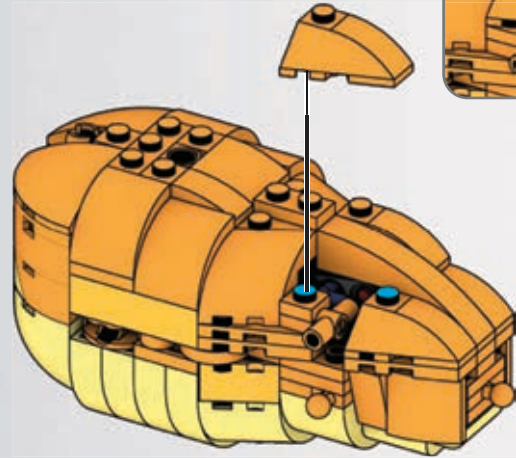
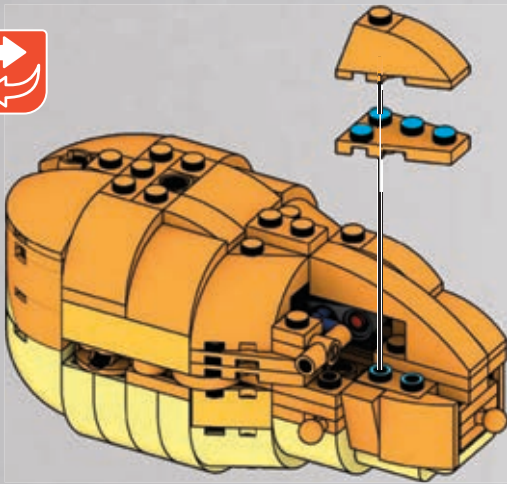



81

1x 2x

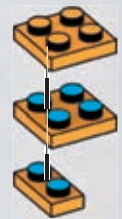

82

1x 1x

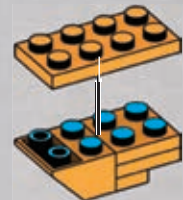

83

2x 1x 1x 1x

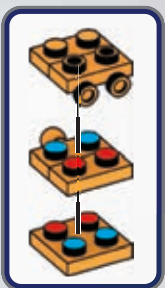

84

1x 2x

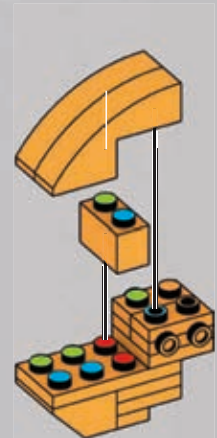

85



1x



1x



1x

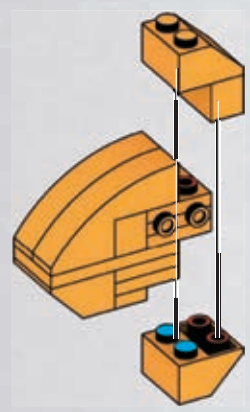
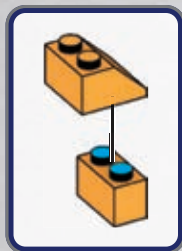

1

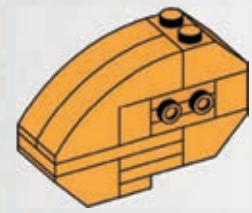

2

86



2x



1x

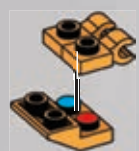

87



2x



1x



1x

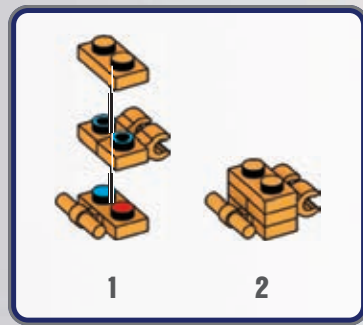

1



2

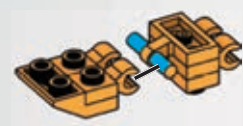

88

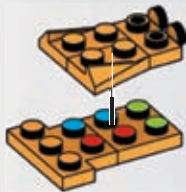
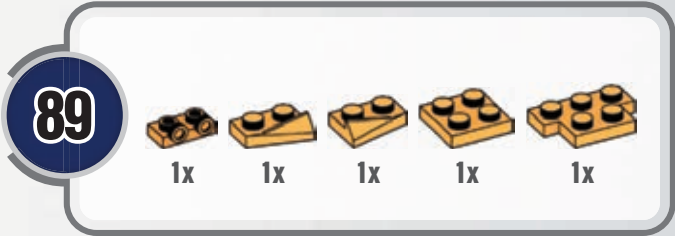
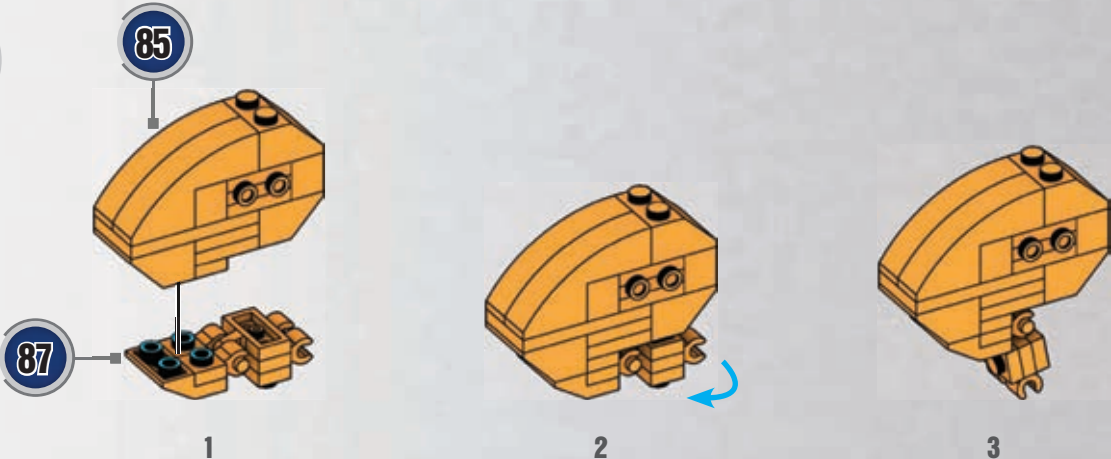

91

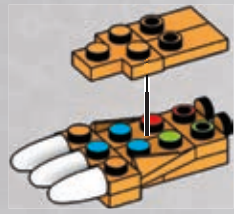

92

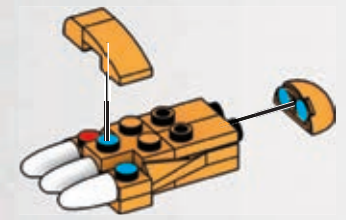

93

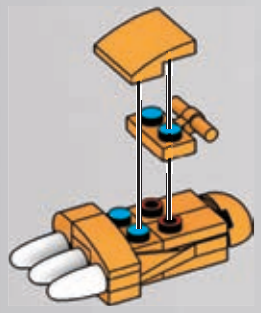

94

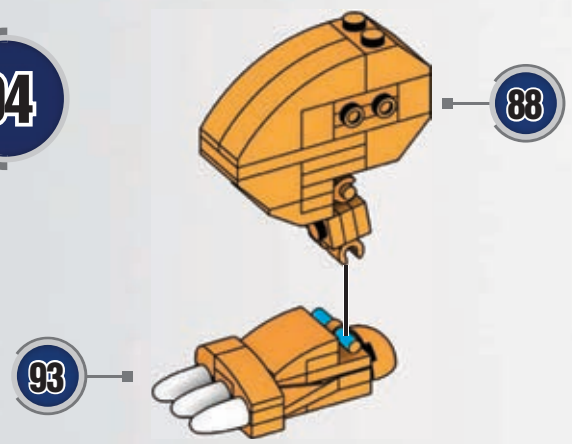

95

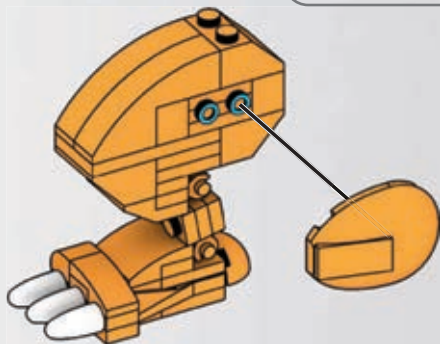
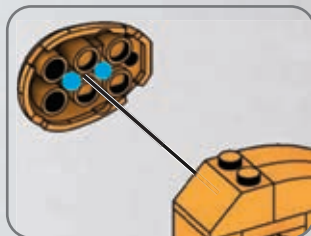
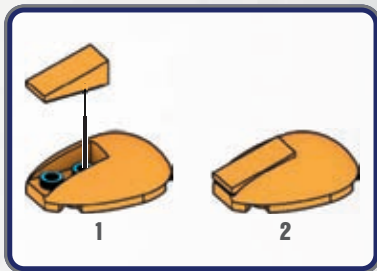

1

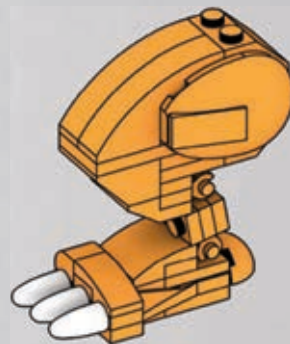

2



96

1x 2x



97

1x 1x

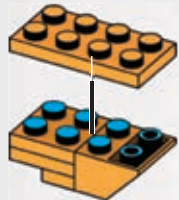

98

2x 1x 1x 1x

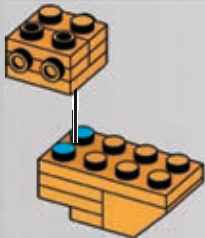
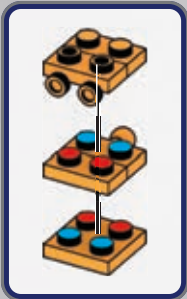

99

1x 2x

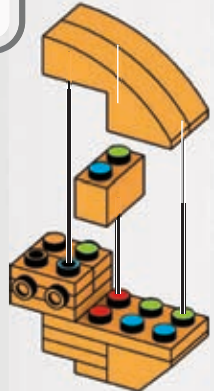

100



1x



1x



1x

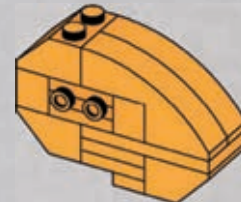
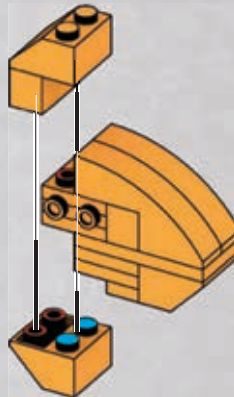
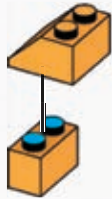

101



2x



1x

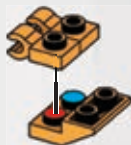

102



2x



1x



1x



1



2

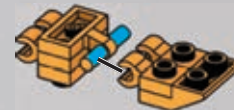

103

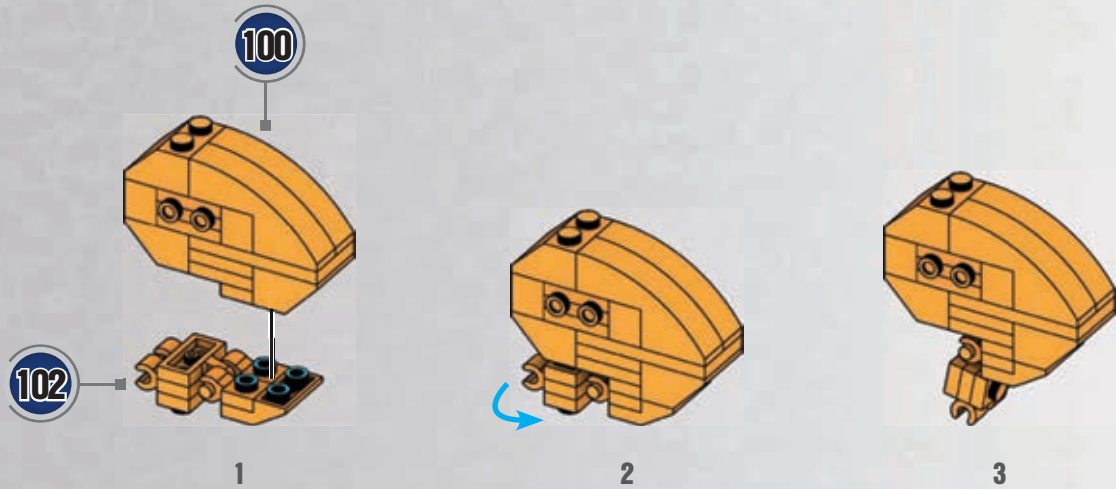

104

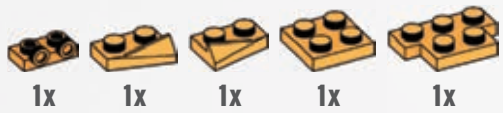

105

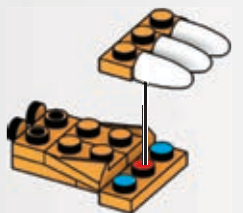
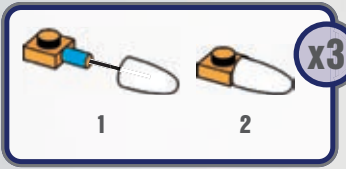
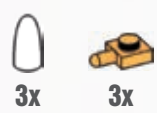

106



2x



1x

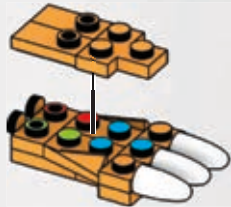

107



1x



1x



1x

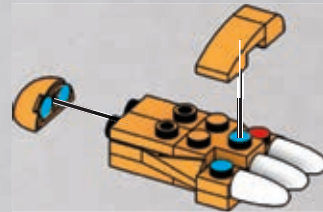

108



1x



1x

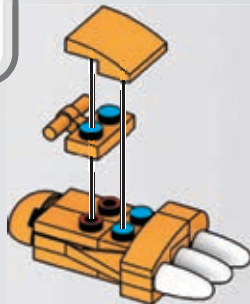

109

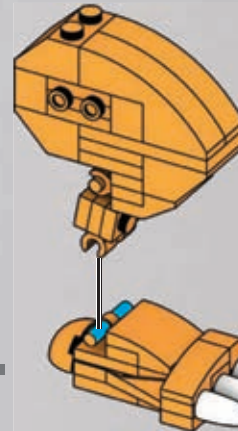

103

108

110

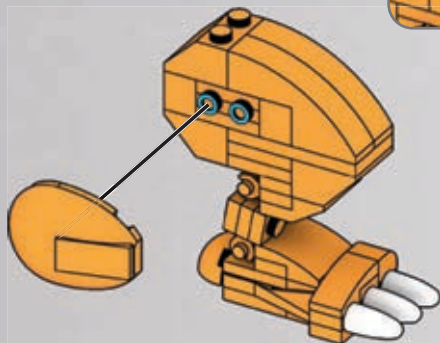
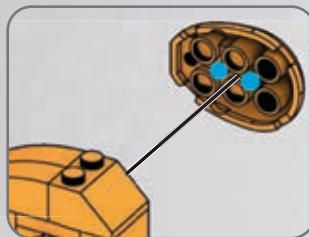
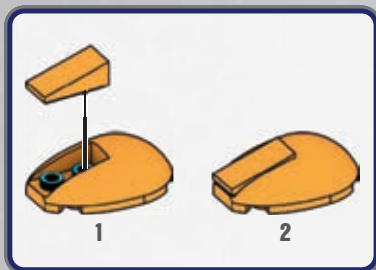

1

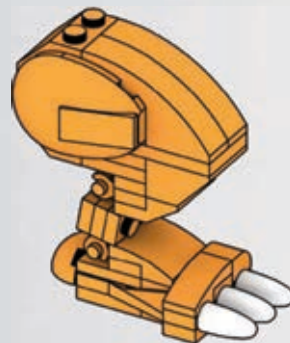

2

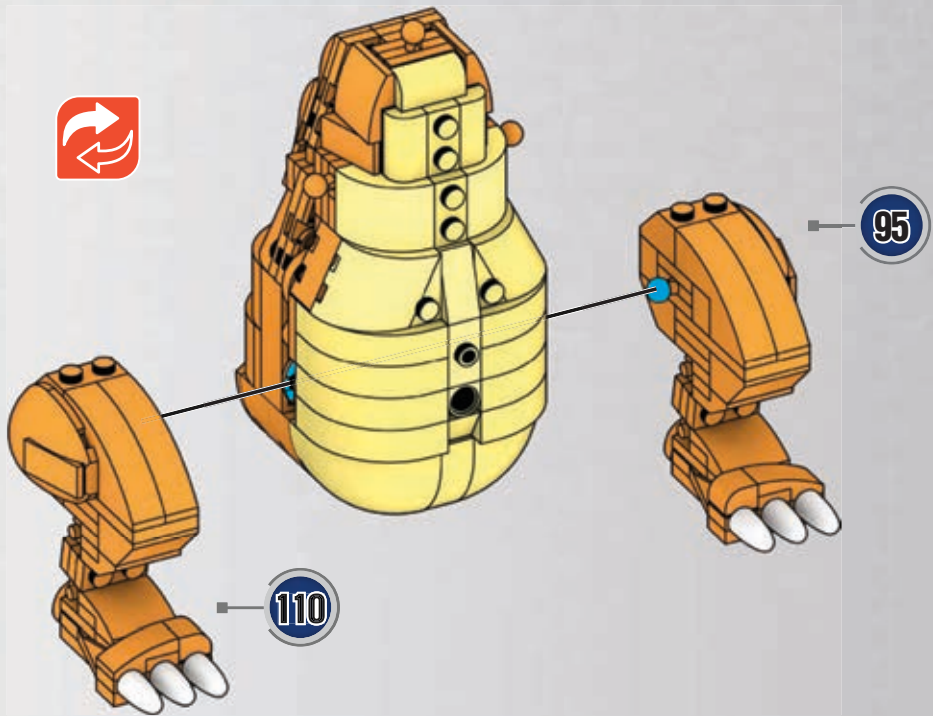



112

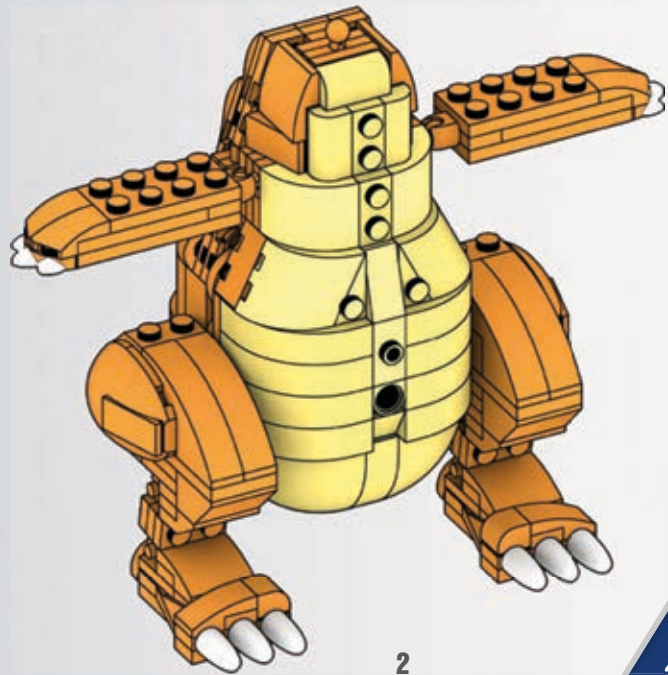
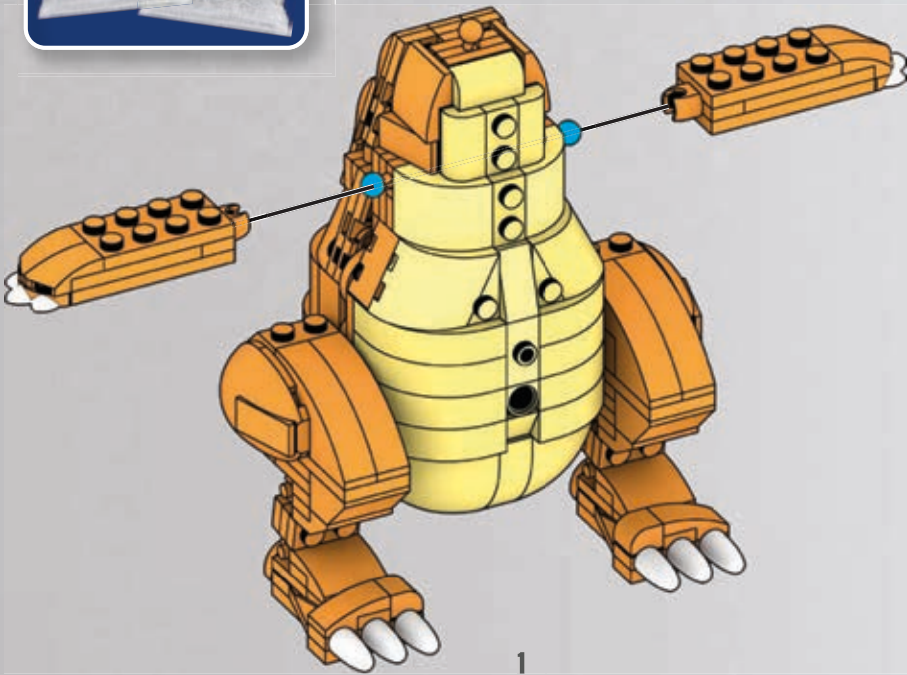
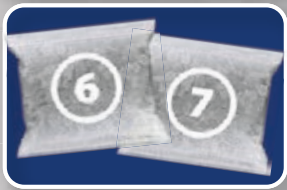
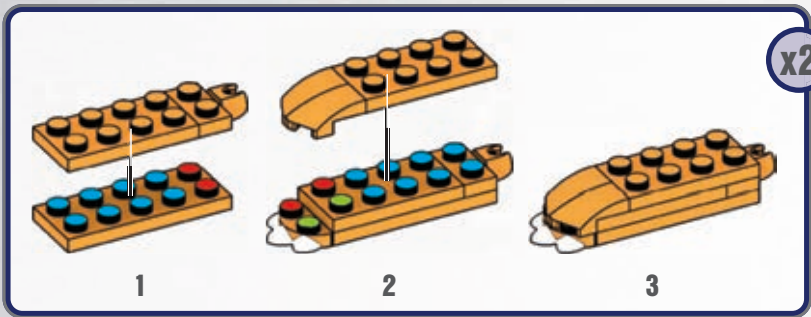
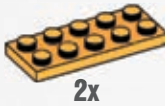
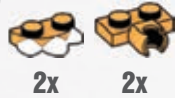



113



1x 1x 1x



114

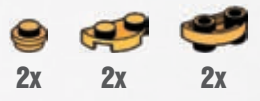

2x 2x 2x

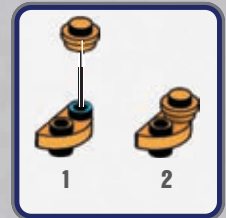
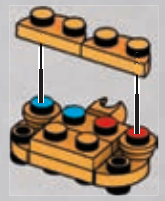

115

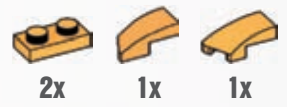

2x 1x 1x

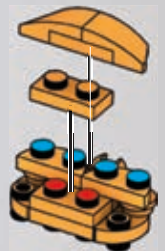

116



2x

2x

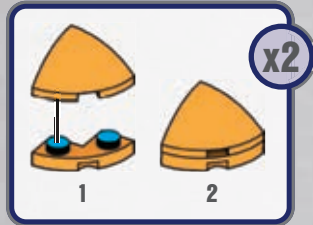

1

2

x2

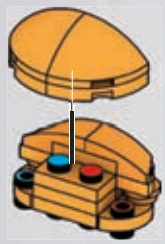

1



2

117



1x

1x

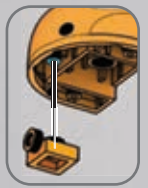

1



2

118



1x



119

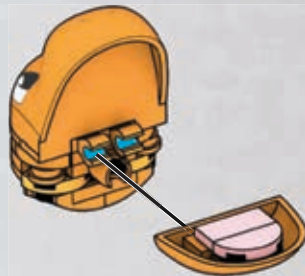

1



2



3

120

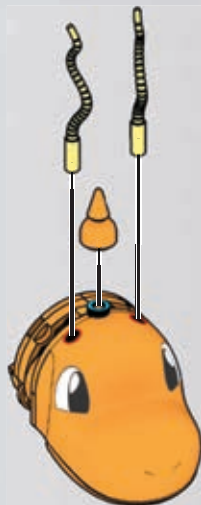

1



2

121

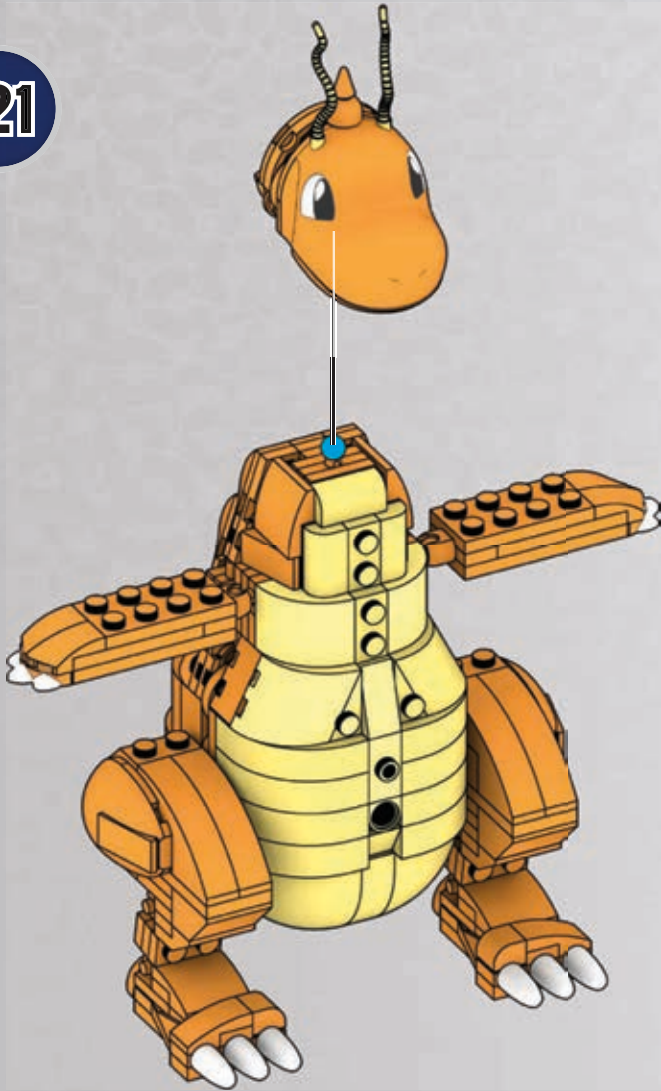

1

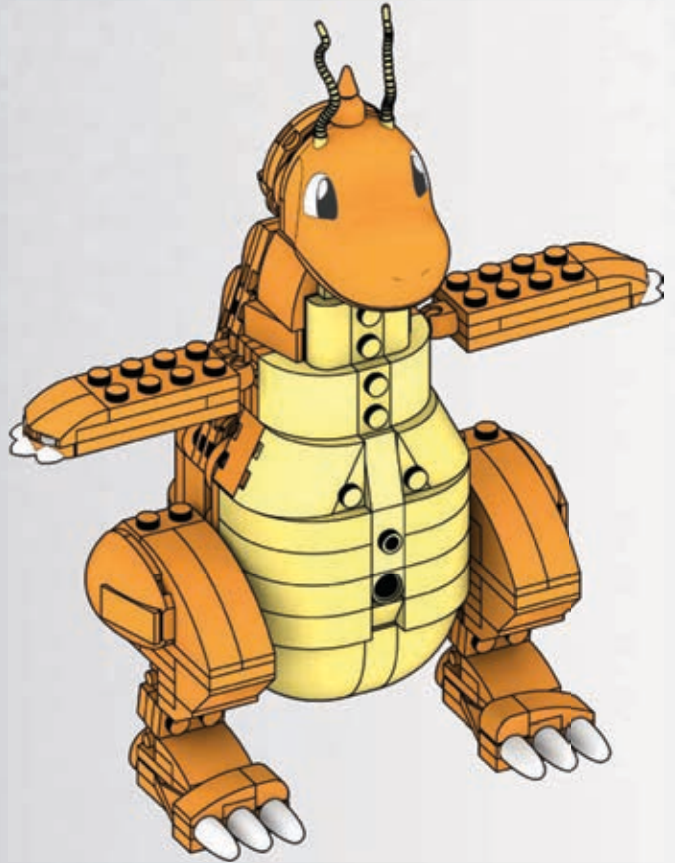

2



122

1x 2x 1x

1x 1x

Parts list for step 122: 1x 1x2 tan brick with 2 black studs, 2x 1x3 tan brick with 2 black studs, 1x 1x2 tan brick with 2 black studs, 1x 1x4 tan brick with 4 black studs, and 1x 1x6 tan brick with 6 black studs.

123

2x 2x

Parts list for step 123: 2x 1x2 tan brick with 2 black studs, and 2x tan Technic wedge.

x2

1 2

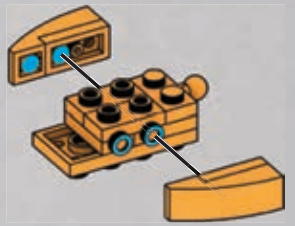
Assembly diagram for step 123: A tan Technic wedge is inserted into a hole in a tan brick with a blue stud. A second tan Technic wedge is shown separately.

124

1x 1x 1x

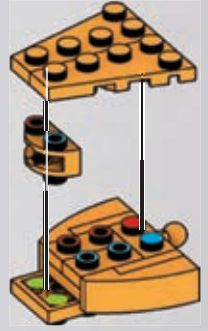
Parts list for step 124: 1x 1x2 tan brick with 2 black studs, 1x 1x4 tan brick with 4 black studs, and 1x 1x6 tan brick with 6 black studs.

125



1x



1x



1x



1x

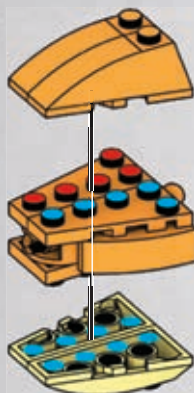

1

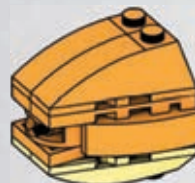

2

126



1x



1x



1x



1x

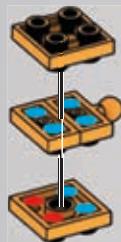

127



1x



1x



1x



128



1x

1x

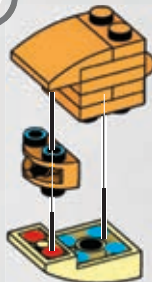

129

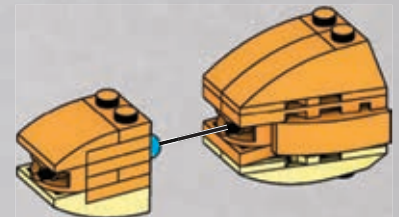

130



1x

2x

2x

1x

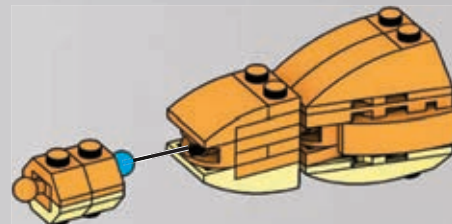
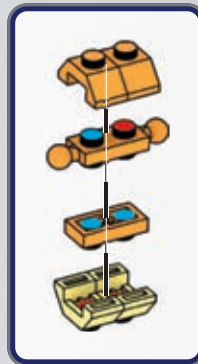

131



1x



1x



1x



1x

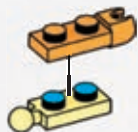

1



2

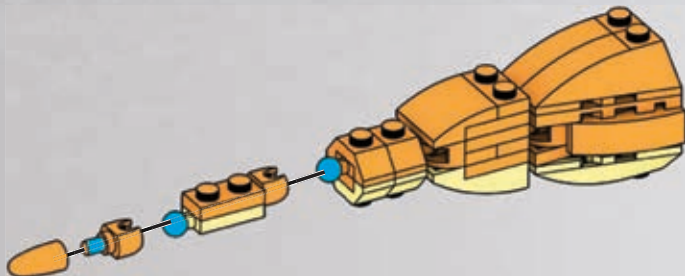

1

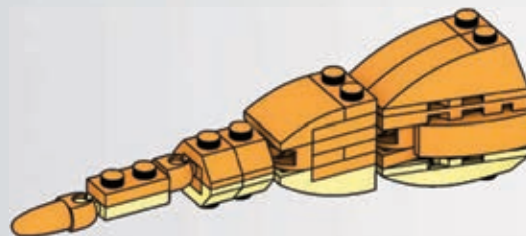

2

132

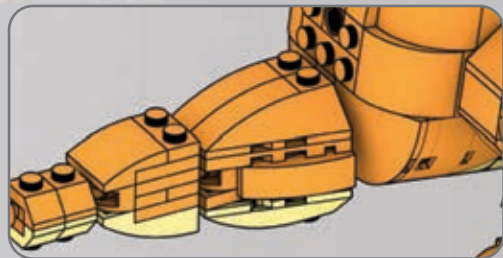
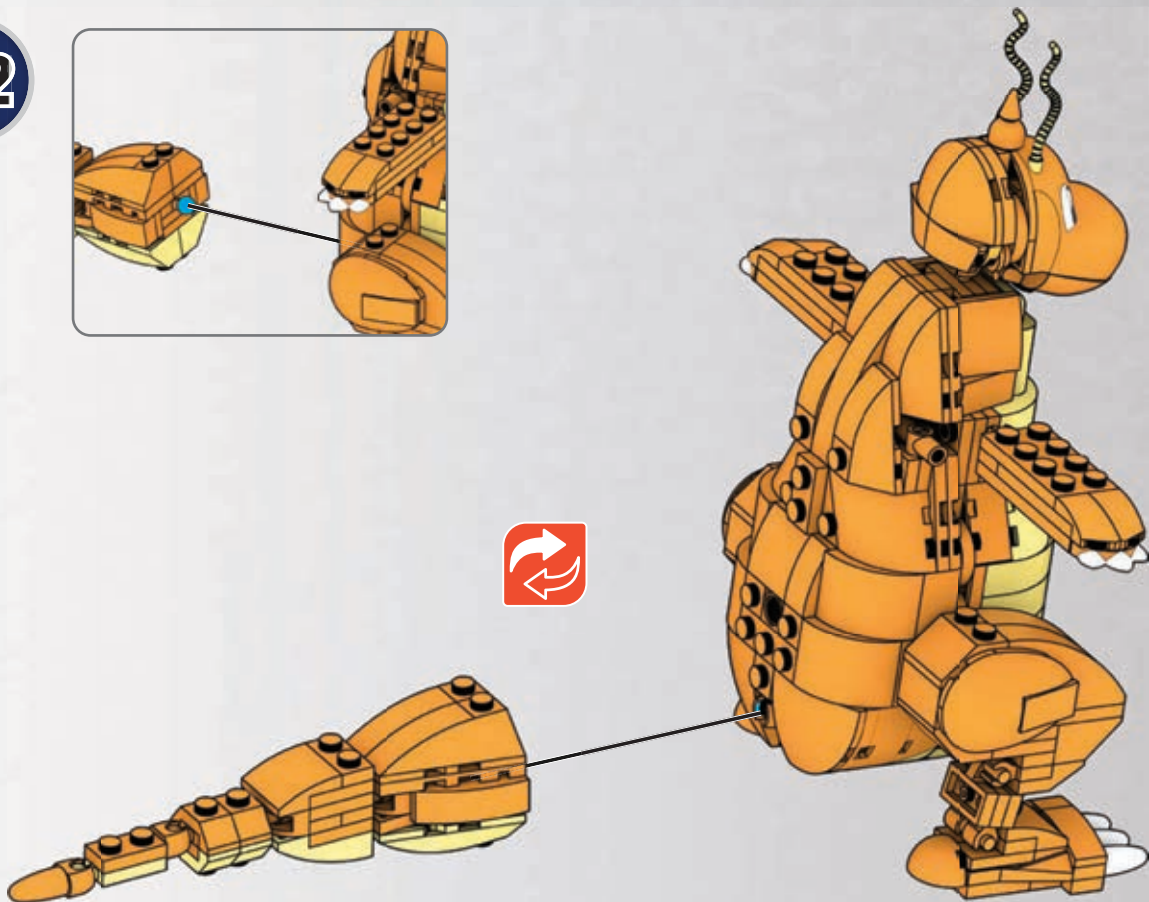
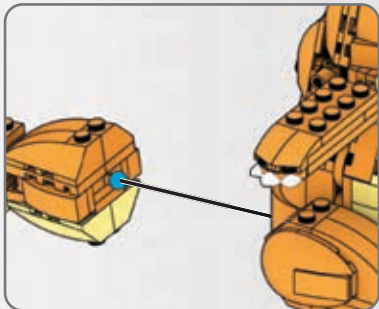

133

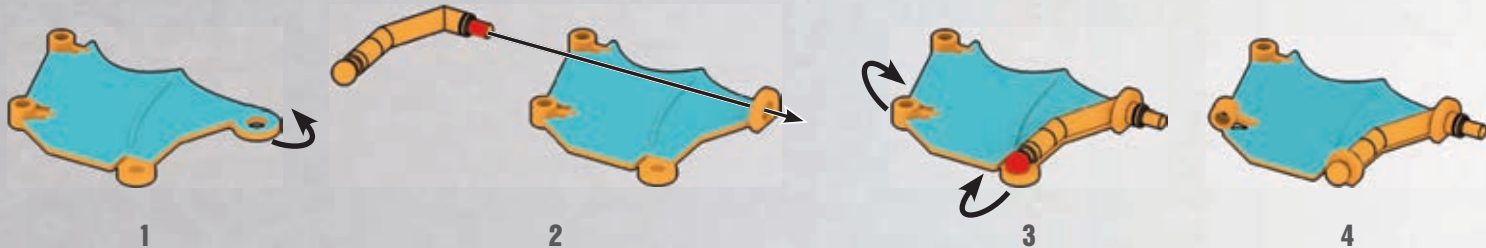
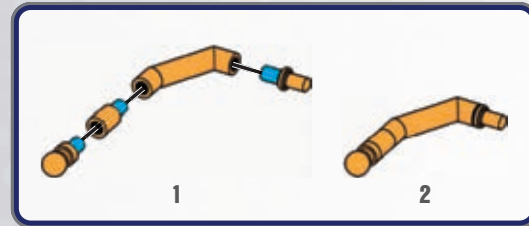

134

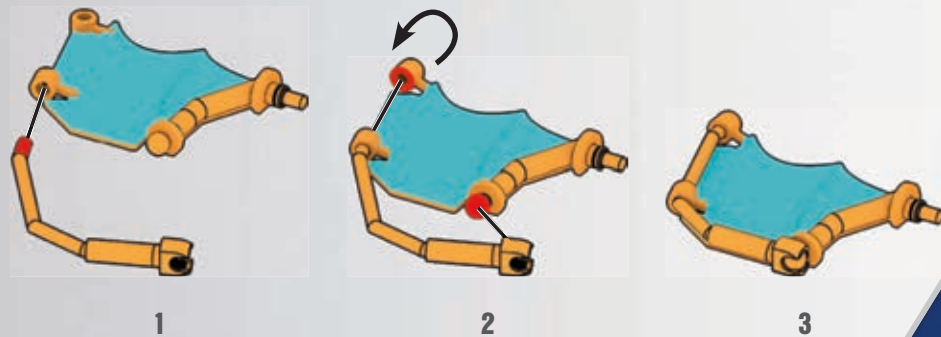
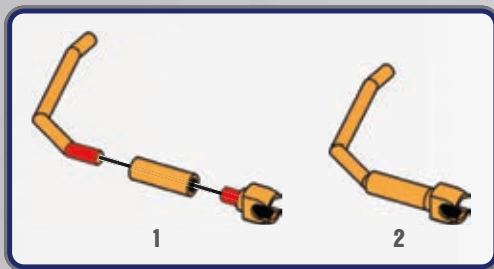

135

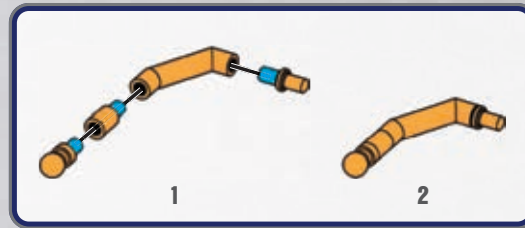

136

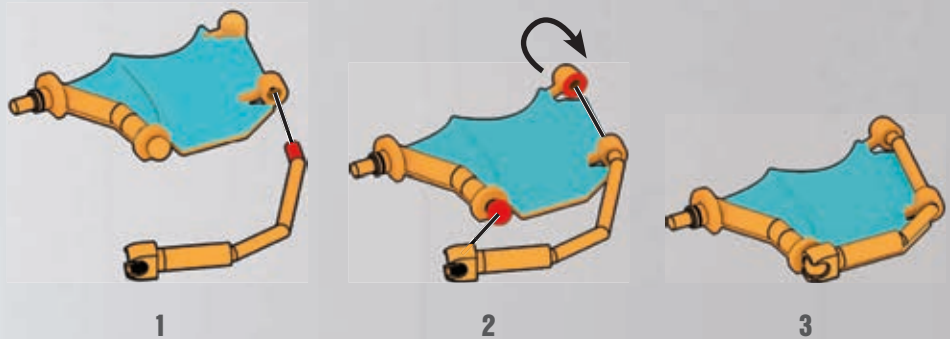
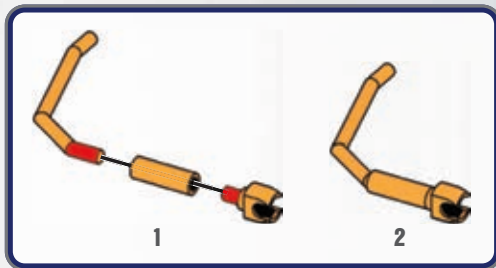

137

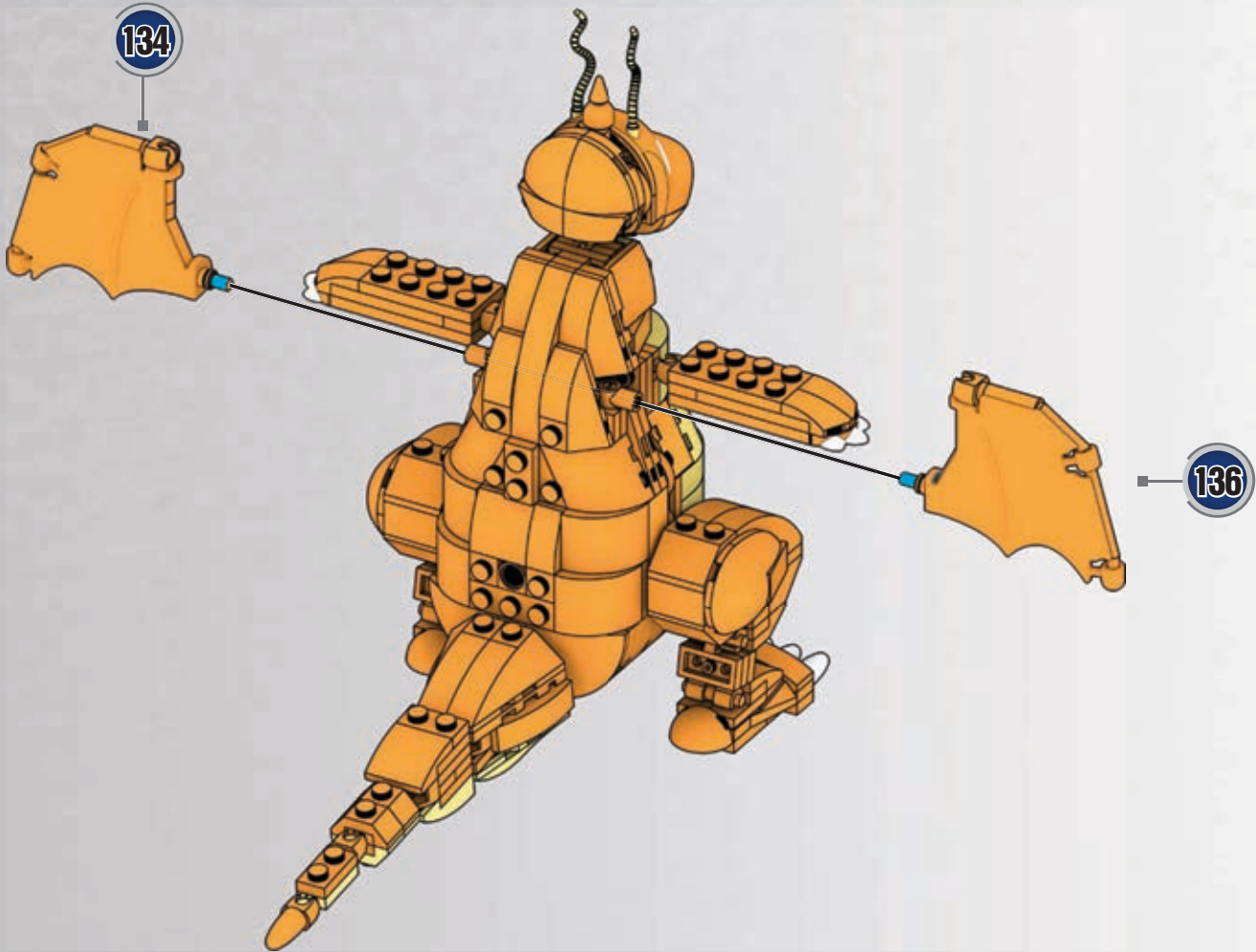

134

136

138



2x



1x



1x

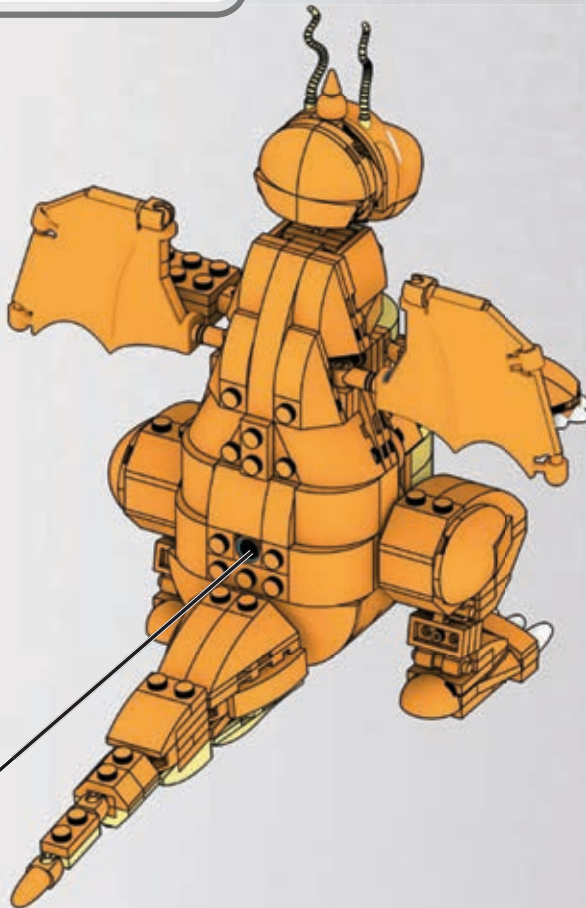
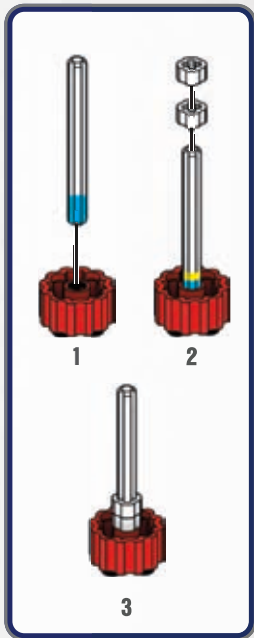

1

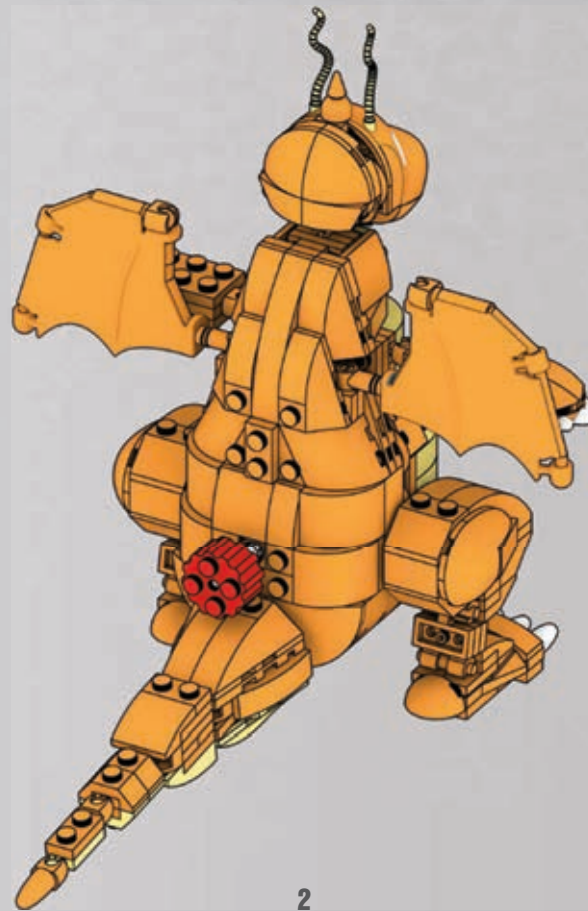

2

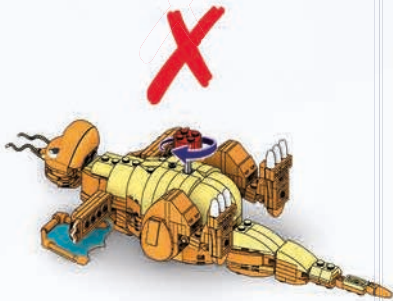
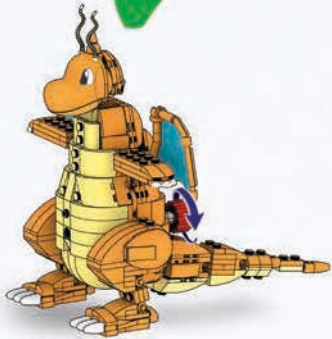



BUILD YOUR WORLD OF POKÉMON WITH MOTION **CONSTRUIS TON MONDE POKÉMON EN MOUVEMENT**

CONSTRUYE TU MUNDO DE POKÉMON CON MOVIMIENTO / CONSTRÓI O TEU MUNDO DE POKÉMON COM MOVIMENTO
EINE EIGENE, BEWEGLICHE POKÉMON WELT BAUEN / ПОСТРОЙ СВОЙ МИР POKÉMON С ДВИЖЕНИЕМ

1

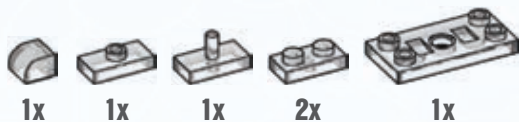

1x

1x

1x

2x

1x

2



4x

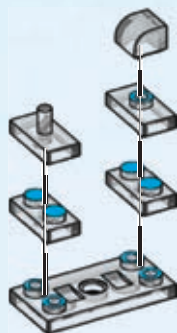

x2



1

2

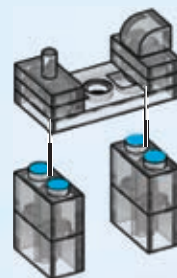

1

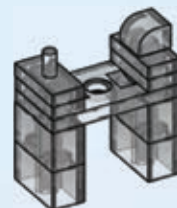

2

3



HKT21

Set(s) sold separately and subject to availability. / Ensemble(s) vendu(s) séparément. Certains produits peuvent ne pas être commercialisés. / Se vende(n) por separado y está(n) sujeto(s) a disponibilidad. / Conjunto(s) vendido(s) em separado e sujeito(s) à disponibilidade. / Set in vendita separatamente, secondo disponibilità. / Das/Die Set(s) sind separat erhältlich. / Zestaw(ry) sprzedawany(e) oddzielnie w zależności od dostępności. / Set(s) apart verkrijgbaar en afhankelijk van beschikbaarheid. / Набор(-ы) продаются отдельно, при наличии. / Sæt sælges separat og så længe lager haves. / Seten säljs separat så länge lagret räcker. / Settet/settene selges separat så langt lageret rekker. / Pakkaus/pakkaukset myydään erikseen, saatavuus voi vaihdella. / Το(α) σετ πωλούνται ξεχωριστά και ανάλογα με τη διαθεσιμότητα. / Setler ayrı olarak satılır ve stoklarla sınırlıdır. / Set (sety) se prodává (prodávají) samostatně dle aktuální nabídky. / Súprava/-y sa predáva(jú) samostatne a podľa dostupnosti. / A készlet(ek) külön kapható(k), az elérhetőség változhat. / セット商品は別売りになります。在庫状況は別途ご確認をお願いします。 /
 تُباع المجموعة أو المجموعات على حدة وتخضع لتوافرها.
 每套单独发售，按供货情况决定。

4

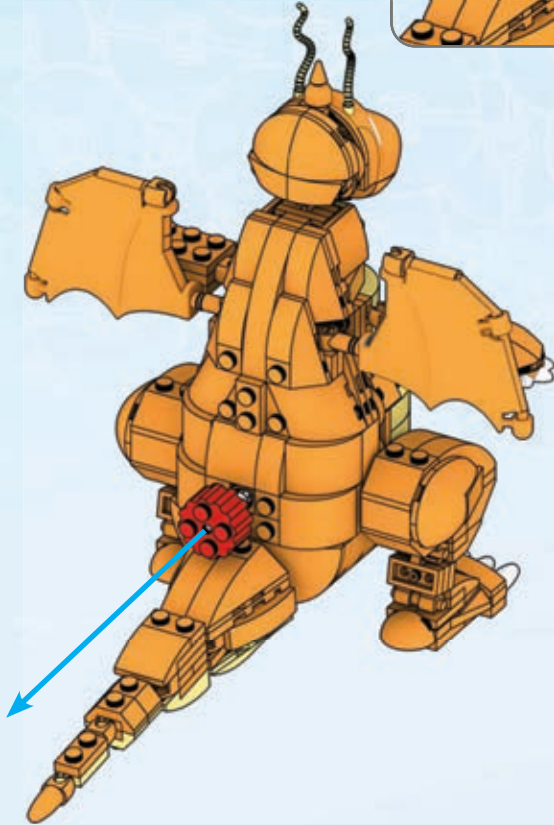
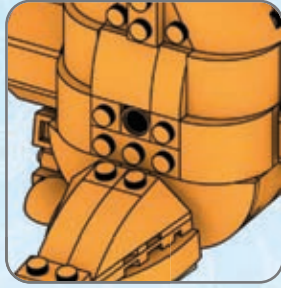

5

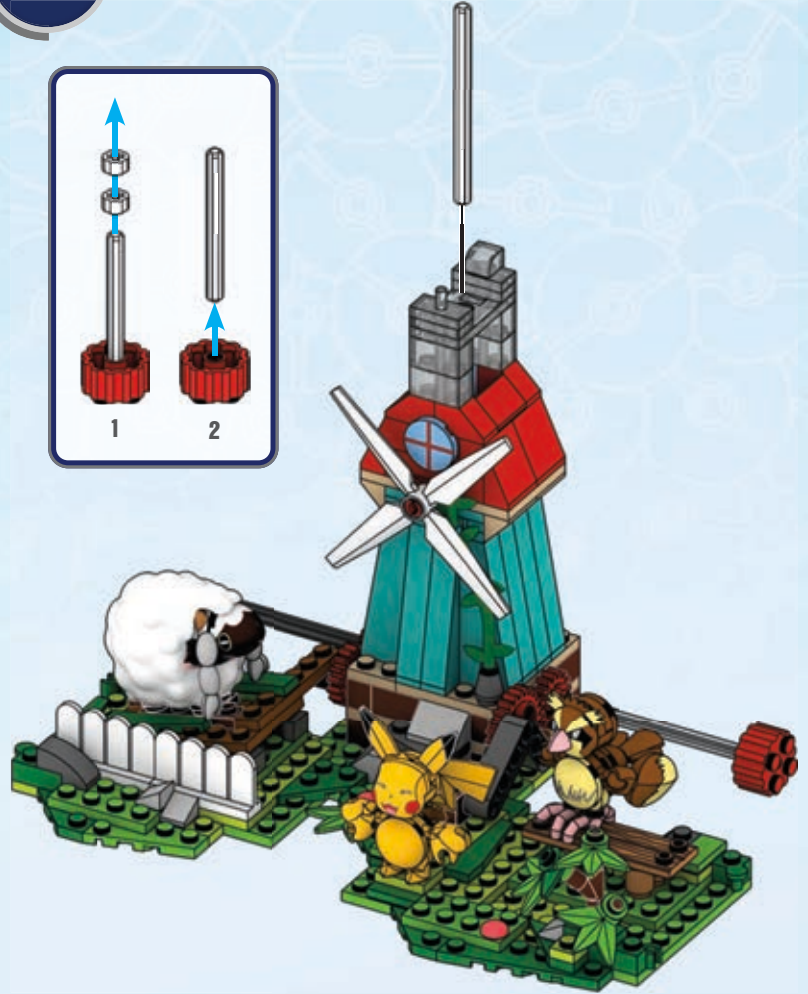
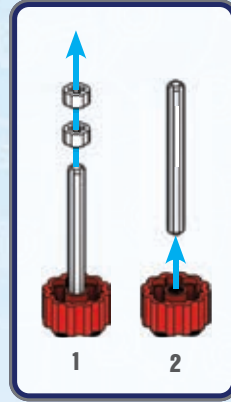

6



1



2

6x AM75332AMC
 1x AM80181FM
 3x AM17003FM
 2x AM01113FM
 1x AM78802FM
 2x AM76558FM
 2x AM79915E
 2x AM74397FM
 6x AM79432E
 1x AM79432FM
 10x AM03328FM
 1x AM79590FM
 2x AM17787FM
 1x AM17787W
 1x AM17127CS
 2x AM80546FM
 6x AM01140FM

8x AM74415FM
 4x AM76058F
 1x AM78275FM
 1x AM80356AMC
 5x AM01086B
 1x AM07629AMC
 3x AM78296FM
 2x AM78291FM
 1x AM78290FM
 2x AM76867FM
 2x AM17506FM
 1x AM73904B
 1x AM18287AMC
 1x AM81660BBG

1x AM79288NU
 2x AM79375FM
 2x AS-FVK75-04
 1x AM022501NU
 4x AM73758FM
 1x AM07590CS
 1x AM07590W
 4x AM79070FM
 28x AM09393FM
 5x AM09393CS
 2x AM09393W
 5x AM16680FM
 8x AM78391FM
 5x AM78397FM
 6x AM76467FM
 3x AM78277FM

2x AM15480FM
 2x AM15481FM
 4x AM16843FM
 1x AM78412FM
 6x AM04322FM
 1x AM80765FM
 2x AM78276FM
 1x AM78276CS
 3x AM74427FM
 3x AM74426FM
 4x AM17128FM
 1x AM17128CS
 1x AM17070W
 2x AM19165CS

2x AM19165FM
 1x AM72534E
 2x AM80799FM
 3x AM78486FM
 4x AM78281FM
 3x AM03017CS
 2x AM17835FM
 9x AM09013FM
 4x AM09013W
 2x AM18293FM
 1x AM72000FM
 14x AM03773FM
 5x AM01146FM
 2x AM18223FM

2x AM74657FM
 4x AM01154FM
 2x AM10273FM
 1x AM74671FM
 1x AM74672FM
 6x AM74106FM
 1x AM78107CS
 1x AM78107FM
 2x AM74298BBG
 11x AM01314FM
 1x AM81260BLG
 2x AM80143FM
 3x AM16384BLG

1x AM18328FM
 2x AM18775FM
 2x AM18776FM
 1x AM17021CS
 3x AM17073FM
 3x AM17074FM
 4x AM03772F
 1x AM03873AMC
 2x AM07230FM
 4x AM77465FM
 2x AM16215CS
 2x AM09593CS
 3x AM09593FM

1x AM81613AMC
 2x AM02212BLG
 1x AM74064FM
 1x AM74065FM
 2x AM01087E
 2x AM08481CS
 4x AM08481FM
 1x AM76222CS
 1x AM76222FM
 1x AM76223CS
 1x AM76223FM

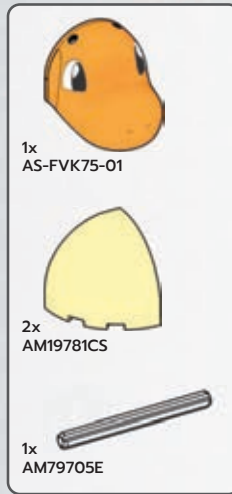
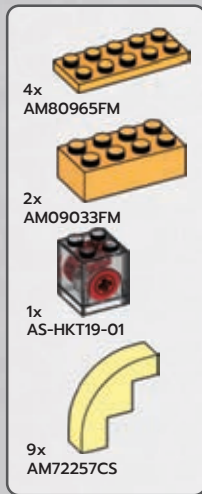
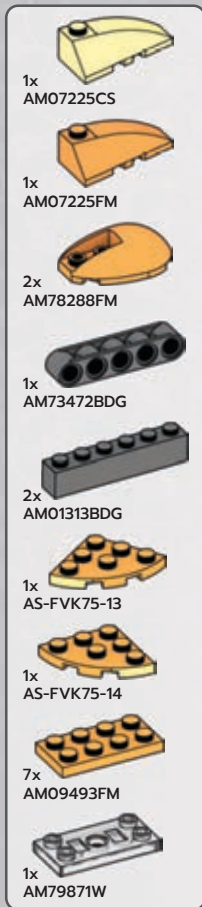

**Missing pieces?
Pièces manquantes?**
¿Partes faltantes? · Perdute peças?
Fehlende Teile? · Не хватает деталей?

? support.megabrand.com

WARNING:
CHOKING HAZARD – Small parts.
Not for children under 3 years.

ATTENTION :
DANGER D'ÉTOUFFEMENT –
PETITS ÉLÉMENTS. NE
CONVIENT PAS AUX ENFANTS
DE MOINS DE 36 MOIS.

ATENÇÃO: NÃO INDICADO / NÃO RECOMENDÁVEL PARA CRIANÇAS MENORES DE 3 (TRÊS) ANOS POR CONTER PARTE(S) PEQUENA(S) QUE PODE(M) SER ENGOLIDA(S) OU ASPIRADA(S) PODENDO PROVOCAR ASFIXIA.

WARNING: Small parts, **ATTENTION :** PETITS ÉLÉMENTS, **ACHTUNG:** Kleine Teile, **AVVERTENZA:** Piccole parti, **WAARSCHUWING:** Kleine onderdelen, **ADVERTENCIA:** PELIGRO DE ATRAGANTAMIENTO. Juguete no recomendado para menores de 3 años, porque contiene piezas pequeñas que podrían provocar asfixia en caso de ser ingeridas o inhaladas por el/la niño/a, **WARNING:** Små delar, **VAROITUS:** Pieniä osia, **ADVARSSEL:** Små dele, **ADVARSSEL:** Små deler, **OSTRZEŻENIE:** Małe części, **UPOZORNĚNÍ:** Malé části, **UPOZORNENIE:** Malé časti, **FIGYELMEZTETÉS:** Kis alkatrészek, **ПРЕДУПРЕЖДЕНИЕ:** Мелкие детали, **ΠΡΟΕΙΔΟΠΟΙΗΣΗ:** Μικρά κομμάτια, **UYARI:** Küçük parçalar.



警告:
のどにつまる危険 小さな部品が含まれています 3歳以下の子供には与えないで下さい。

警告! 不适合3岁以下儿童使用。内含小零件。

Mattel Europa B.V., Gondel 1, 1186 MJ Amstelveen, Nederland. Mattel U.K. Limited, The Porter Building, 1Brunel Way, Slough SL1 1FQ, UK. Mattel France, Parc de la Ceraise, 1/3/5 allée des Fleurs, 94260 Fresnes Cedex. N° Cristal 0969 36 99 99 (Numéro non surtaxé) ou www.lesjouetsmattel.fr Mattel Belgium N.V. De Kleetlaan 4, 1831 Machelen (Diegem) Belgium. Deutschland : Mattel GmbH, Solmsstraße 83, D-60486 Frankfurt am Main. Schweiz: Mattel AG, Kirchstrasse 24, CH-3097 Liebefeld. Österreich: Mattel Ges.m.b.H., Campus 21, Liebermannstraße A01 404, A-2345 Brunn/Gebrige. Mattel Italy Srl, Via Turati 4, 20121 Milano, Italy. Servizio assistenza clienti: Customersrv.it@mattel.com - Numero verde 800 11 37 11. Mattel España, S. A. Aribau 200 pl. 9, 08036 Barcelona. cservice.spain@mattel.com Tel: +34 933 06 79 00 <http://www.service.mattel.com/es>. Hong Kong: Kids Kingdom Limited, Room 1908-9, Gala Place, 56 Dundas Street, Mongkok, Kowloon, Hong Kong. Customer Care line: (852)2782-0766. Taiwan: Chickabiddy Company Limited, 5/F, No. 186, Section 4, Nanjing East Road, Taipei 10595, Taiwan. Customer Care line: (02)2578-1188. Mainland China: Mattel Barbie (Shanghai) Trading Co., Ltd. Units 4701-4711, 47F, 2 Grand Gateway, 3 Hong Qiao Road, Shanghai, 200030, P.R.C. Customer Care line: 400-819-8658. Diimport & Diedarkan Oleh: Mattel Continental Asia Sdn Bhd. Level 19, Tower 3, Avenue 7, No. 8, Jalan Kerinci, Bangsar South, 59200 Kuala Lumpur, Malaysia. Mattel South Africa (PTY) LTD, Office 10213, 30 Melrose Boulevard, Johannesburg 2196. The Forum, Văclavské nám. 19, 11000 Praha 1, Mattel, 333 Continental Boulevard, El Segundo, CA 90245, USA. Consumer Services: 1-800-465-MEGA (6342). Mattel Canada Inc., Mississauga, Ontario L5R 3W2. Consumer Services: You may call us free at/ Composez sans frais le 1-800-524-8697. Importado y distribuido por Mattel de México, S.A. de C.V., Miguel de Cervantes Saavedra No. 193, Pisos 10 y 11, Col. Granada, Alcaldía Miguel Hidalgo, C.P. 11520, México, Ciudad de México. R.F.C. MME-920701-NB3. Tels.: 59-05-51-00 Ext. 5206 6 01-800-463-59-89. Mattel Chile S.A., Pde. Riesco 5561, Of. 203-204 PS2, Las Condes, Santiago. Servicio al consumidor Venezuela: Tel: 0-800-100-9123. Mattel Argentina, S.A., Av. Libertador 1000, Piso 11 - Oficinas 109 y 111, Vicente López - Prov. Buenos Aires. Tel: 0800-666-3373. Mattel Colombia, S.A., Calle 123#7-07 P.5. Bogotá. Tel: 01800-710-2069. Mattel Perú, S.A., Av. Juan de Arona n° 151, Centro Empresarial Juan de Arona, Torre C, Piso 7, Oficina 704, San Isidro, Lima 27, Perú. RUC: 20425853865. Reg. Importador: 02350-12-JUE-DIGESA. Tel: 0800-54744. E-mail Latinoamérica: servicio.clientes@mattel.com. Mattel do Brasil Ltda. - CNPJ: 54.558.002/0001-20 - Rua Verbo Divino, 1488 - 2º. Andar - 04719-904 - Chácara Santo Antônio - São Paulo - SP - Brasil. Serviço de Atendimento ao Consumidor: Contato: <https://faleconosco.mattel.com.br/Contato>. E-mail: sacmattel@brasil.mattel.com.



HTH86



HKT21



HKT69



HKT25

BUILD YOUR WORLD OF POKÉMON WITH MOTION CONSTRUIS TON MONDE POKÉMON EN MOUVEMENT



Construye tu mundo de Pokémon con movimiento / Constrói o teu mundo de Pokémon com movimento
Eine eigene, bewegliche Pokémon Welt bauen / Построй свой мир Pokémon с движением





*HKT19 / HKT20 / HKT21 / HKT25 / HDL76 / HDL77 / HDL80 / HDL86 / HHN61 / HTH69 / HTH89

Set(s) sold separately and subject to availability. / Ensemble(s) vendu(s) séparément. Certains produits peuvent ne pas être commercialisés. / Se vende(n) por separado y está(n) sujeto(s) a disponibilidad. / Conjunto(s) vendido(s) em separado e sujeito(s) à disponibilidade. / Set in vendita separatamente, secondo disponibilità. / Das/Die Set(s) sind separat erhältlich. / Zestaw(y) sprzedawany(e) oddzielnie w zależności od dostępności. / Set(s) apart verkrijgbaar en afhankelijk van beschikbaarheid. / Набор(-ы) продаются отдельно, при наличии. / Sæt sælges separat og så længe lager haves. / Seten säljs separat så länge lagret räcker. / Settet/settene selges separat så langt lageret rekker. / Pakkaus/pakkaukset myydään erikseen, saatavuus voi vaihdella. / Το(α) σετ πωλούνται ξεχωριστά και ανάλογα με τη διαθεσιμότητα. / Setler ayrı olarak satılır ve stoklarla sınırlıdır. / Set (sety) se prodává (prodávají) samostatně dle aktuální nabídky. / Súprava/-y sa predáva(jú) samostatne a podľa dostupnosti. / A készlet(ek) külön kapható(k), az elérhetőség változhat. / セット商品は別売りになります。在庫状況は別途ご確認をお願いします。 / تباع المجموعة أو المجموعات على حدة وتخضع لتوافرها. / 每套单独发售，按供货情况决定。

©2022 Pokémon. ©1995–2022 Nintendo / Creatures Inc. / GAME FREAK inc. TM, ®, and character names are trademarks of Nintendo.

©2022 Pokémon. ©1995–2022 Nintendo/Creatures Inc./GAME FREAK inc. TM, ® et les noms des personnages sont des marques de Nintendo.



HDL76*

HDL77*



HDL80*

HDL86*



HHN61*



HKT21*

HKT19*



HKT20*

HKT25*

BUILD A WORLD OF POKÉMON CRÉEZ VOTRE UNIVERS POKÉMON

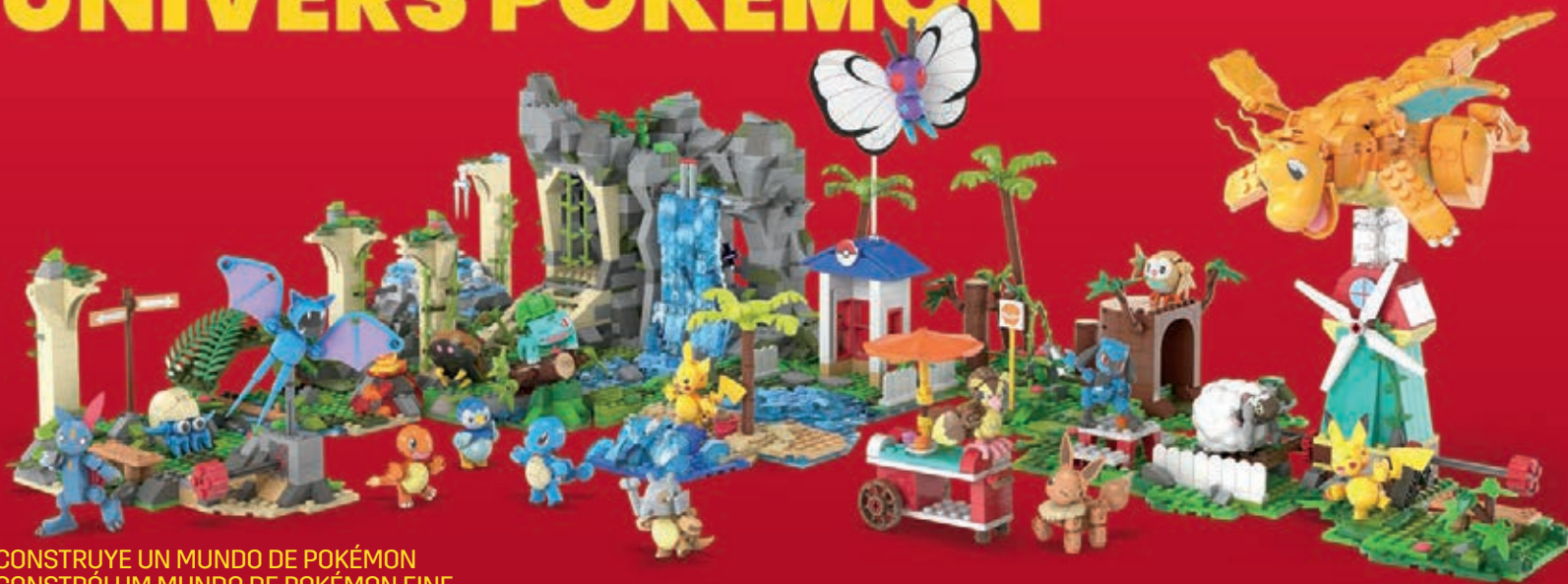

CONSTRUYE UN MUNDO DE POKÉMON
CONSTRÓI UM MUNDO DE POKÉMON EINE
POKÉMON WELT ERSCHAFFEN
ПОСТРОЙТЕ МИР POKÉMON

Mattel Canada Inc. Mississauga, Ontario L5R 3W2.
MADE IN CHINA. FABRIQUÉ EN CHINE. FABRICADO NA CHINA. HECHO EN CHINA.
ИЗГОТОВЛЕНО В КИТАЕ. ÇIN'DE ÜRETİLMİŞTİR. صنع في الصين

©D781,964, D797,203, D799,607, D841,101, D834,105

1186 MJ, 1, NL

©2022 MEGA Brands &™ MEGA Brands.

Printed in China / Imprimé en Chine

AD-HKT25-02A



Adresses sur quefairedemesdechets.fr

